

Slika

Bogdan, David

Supplement / Prilog

Publication year / Godina izdavanja: **2016**

Permanent link / Trajna poveznica: <https://urn.nsk.hr/urn:nbn:hr:122:865203>

Rights / Prava: [In copyright](#)/[Zaštićeno autorskim pravom.](#)

Download date / Datum preuzimanja: **2024-12-27**



Repository / Repozitorij:

[University North Digital Repository](#)

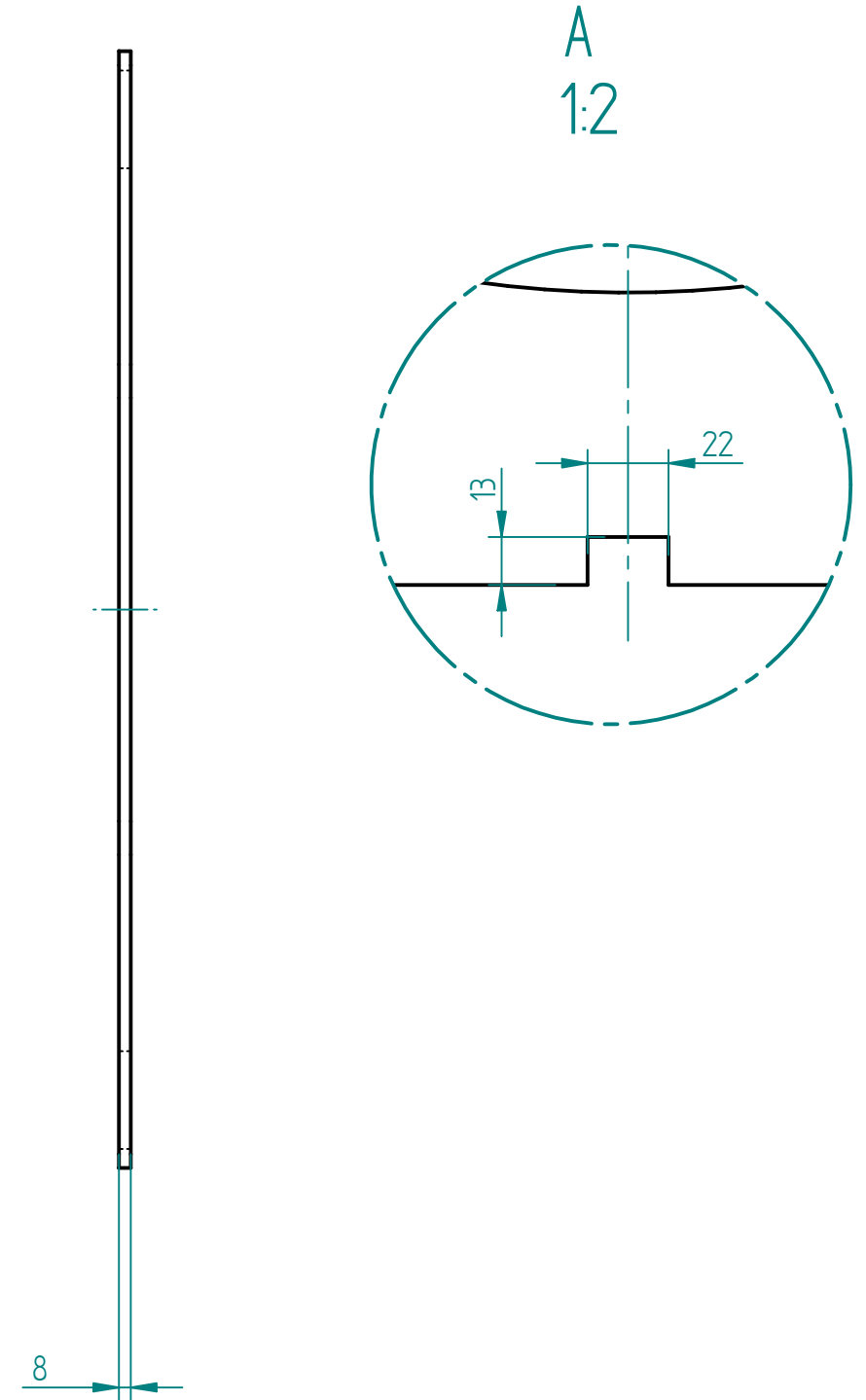
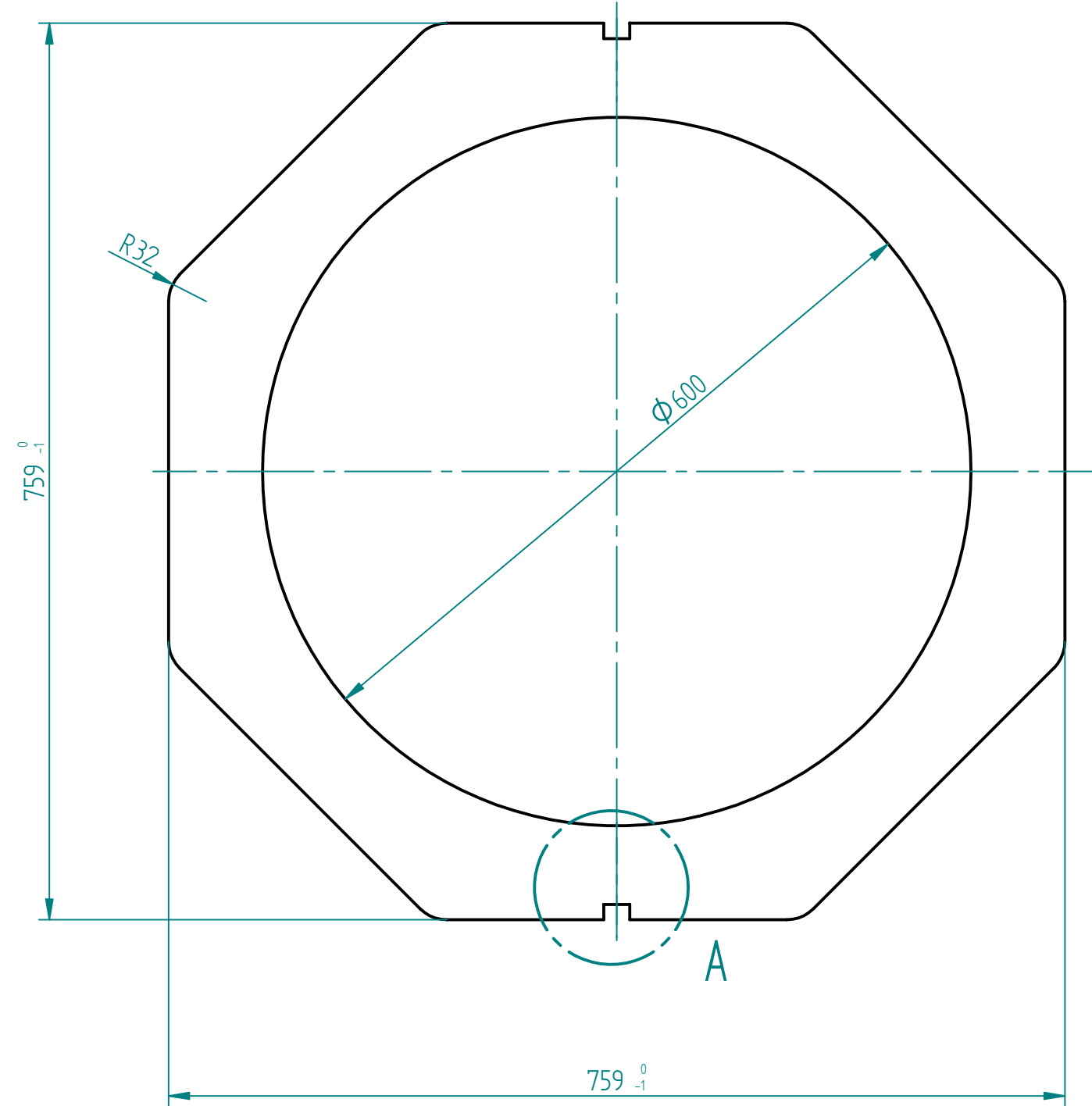

| | | |
|---|----------------------------|-------------------------------------|
| Allgemeintoleranz siehe Werknorm 1.5 / General Tolerances WN-No.: 1.5 | | |
| Dokumenteninfosatz-Nr. / DIS NO: 1000031633 | | Material-Nr. / PART NO: 10208222 |
| Rev. / REV 05 | Datum / DATE 03.05.2011 | Name / NAME NJURIC |
| Blatt-Nr. / SHEET: 1 / 1 | | SCHWING |

| | | | | | |
|--|---|------------------------|------------------------|----------------------------------|-------------------------------------|
| Schutzvermerk DIN 34-1-D Copyright reserved Schwing GmbH | Format / SIZE: A3 | Datum / DATE: 16.03.04 | Name / NAME: J.Richter | Sicherheitsteil / SAFETY PART: N | Benennung / NAME: Blech Plate |
| | Gezeichnet / DRAWN BY | 16.03.04 | J.Richter | Gewicht / WEIGHT (kg): 12,167 | |
| | Geprüft / CHECKED BY | 04.05.2011 | LMEINKE | Maßstab / SCALE: 1:5 | |
| | Normgeprüft / APPROVED BY | | | Nicht abmessen / DO NOT SCALE | |
| | Werkstoff / Werkstoff-Nr.: / MATERIAL / MATERIAL CODE: S690QL / 1.8928 | | | | |
| Ers. durch / REPL. BY: | | | | | |
| Ers. für / REPL. FOR: | | | | | |
| Ung.-Datum/EXPIRY DATE: | | | | | |