

Podatkovna mreža epizoda animirane serije Profesor Baltazar

Krištofić, Magdalena

Supplement / Prilog

Publication year / Godina izdavanja: **2020**

Permanent link / Trajna poveznica: <https://um.nsk.hr/um:nbn:hr:122:478252>

Rights / Prava: [In copyright](#)/[Zaštićeno autorskim pravom.](#)

Download date / Datum preuzimanja: **2024-07-18**

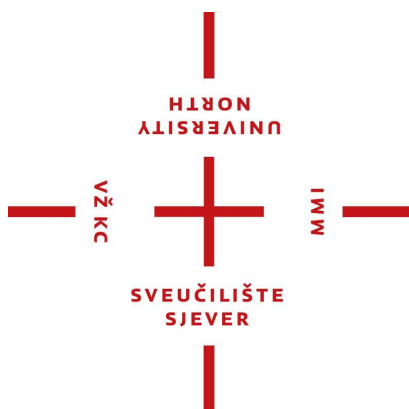

Repository / Repozitorij:

[University North Digital Repository](#)

Naslov rada: Podatkovna mreža epizoda animirane serije Profesor Baltazar

Student: Magdalena Krištofić

Mentor: Andro Giunio, doc. art.

Fakultet: Sveučilište Sjever

Odjel: Odjel za umjetničke studije

Studij: Diplomski sveučilišni studij Medijski dizajn

Kolegij: Vizualizacija informacija

Broj diplomskog rada: 23/MEDD/2020

Matični broj studenta: 0571/336D

Mjesto: Koprivnica

Godina: 2020.

Sadržaj

Sezona 1

- 01 Izumitelj cipela, 3
- 02 Hanibalove Alpe, 4
- 03 Horacijev uspon i pad, 5
- 04 Leteći Fabijan, 6
- 05 Maestro Koko, 7
- 06 Martin na vrhu, 8
- 07 O mišu i satovima, 9
- 08 Rođendanska priča, 10
- 09 Sreća u dvoje, 11
- 10 Tetke Pletke, 12
- 11 Viktorov jajomat, 13
- 12 Vjetrovita priča, 14
- 13 Zvezdani kvartet, 15

Sezona 2

- 01 Alfred noćni čuvar, 16
- 02 Bim–Bum, 17
- 03 Čudotvorni kolač, 18
- 04 Doktor za životinje, 19
- 05 Duga Profesora Baltazara, 20
- 06 Figaro Hop, 21
- 07 Krojač Silvestar, 22
- 08 Ledeno vruće, 23
- 09 Lutke bez kose, 24
- 10 Oblačna priča, 25
- 11 Problem nespretnosti, 26
- 12 Zvonko sa zvonika, 27
- 13 Najveći snjegović, 28

Sezona 3

- 01 Amadeusove uši, 29
- 02 Drama oko cvijeća, 30
- 03 Gusarski problem, 31
- 04 Lavlje nevolje, 32
- 05 Maxol, 33
- 06 Neman Fu–Fu, 34
- 07 Oblačno sa svađavinama, 35
- 08 Pepino Cicerone, 36
- 09 Pingvin Čarli, 37
- 10 Stonožica Božica, 38
- 11 Svirka za Mirka, 39
- 12 Vatrogasna priča, 40
- 13 Veseli most, 41

Sezona 4

- 01 Baltazarova ljubav, 42
- 02 Baltazarov sat, 43
- 03 Duhovita priča, 44
- 04 Dva cilindra, 45
- 05 Hik, 46
- 06 Izgubljeni zec, 47
- 07 Igrati se lovice, 48
- 08 Klaun Danijel, 49
- 09 Obučar Kroko, 50
- 10 Operna zvijezda, 51
- 11 Pingvin Axel, 52
- 12 Posao je posao, 53
- 13 Ptica, 54

- 14 Sportski život, 55
- 15 Šampion, 56
- 16 Ulični svirači, 57
- 17 Veliko hrkanje, 58
- 18 Violeta i Franc, 59
- 19 Vjetrenjača, 60
- 20 Zrak, 61

Augustova treća sreća, 62

01 Izumitelj cipela

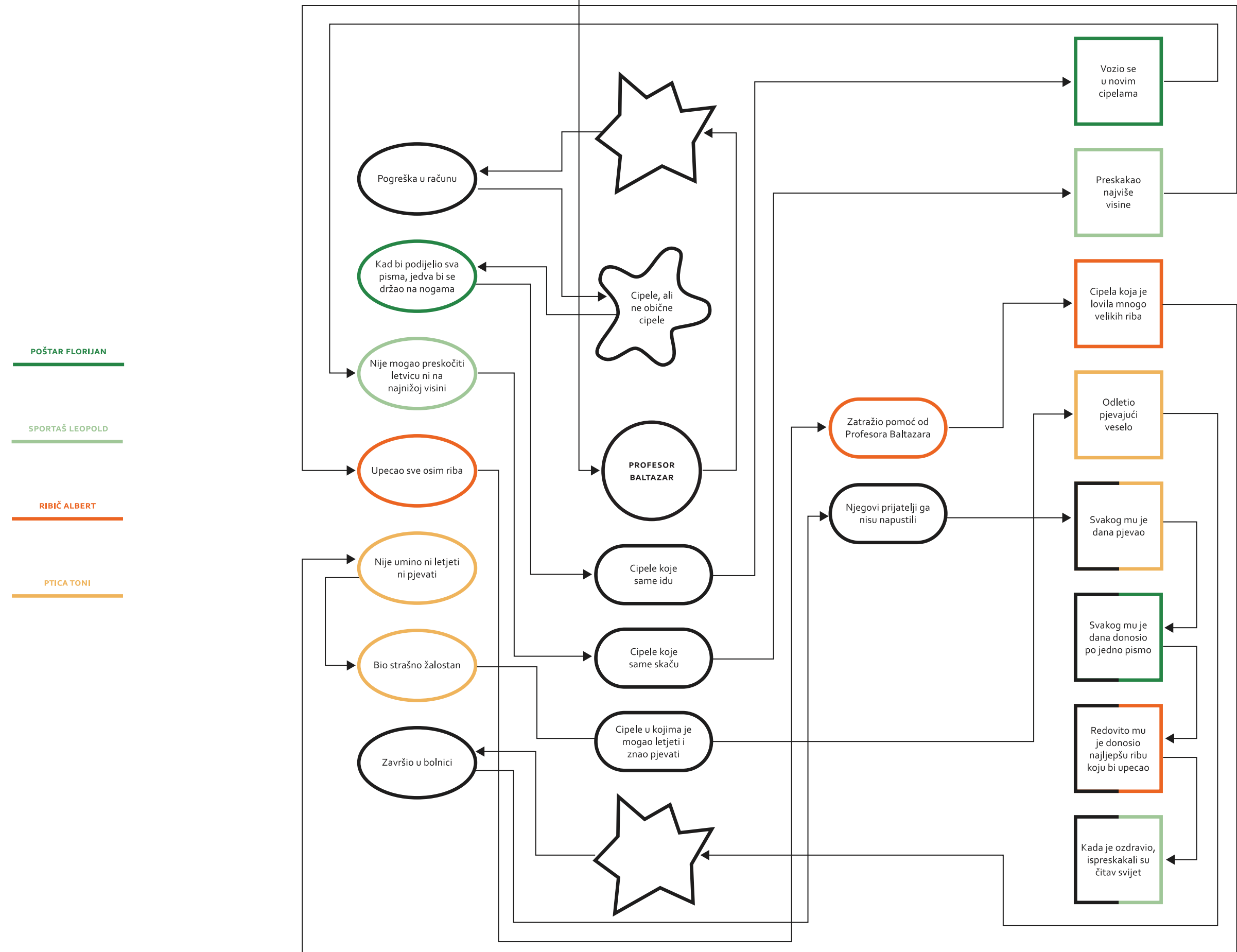

02 Hanibalove Alpe

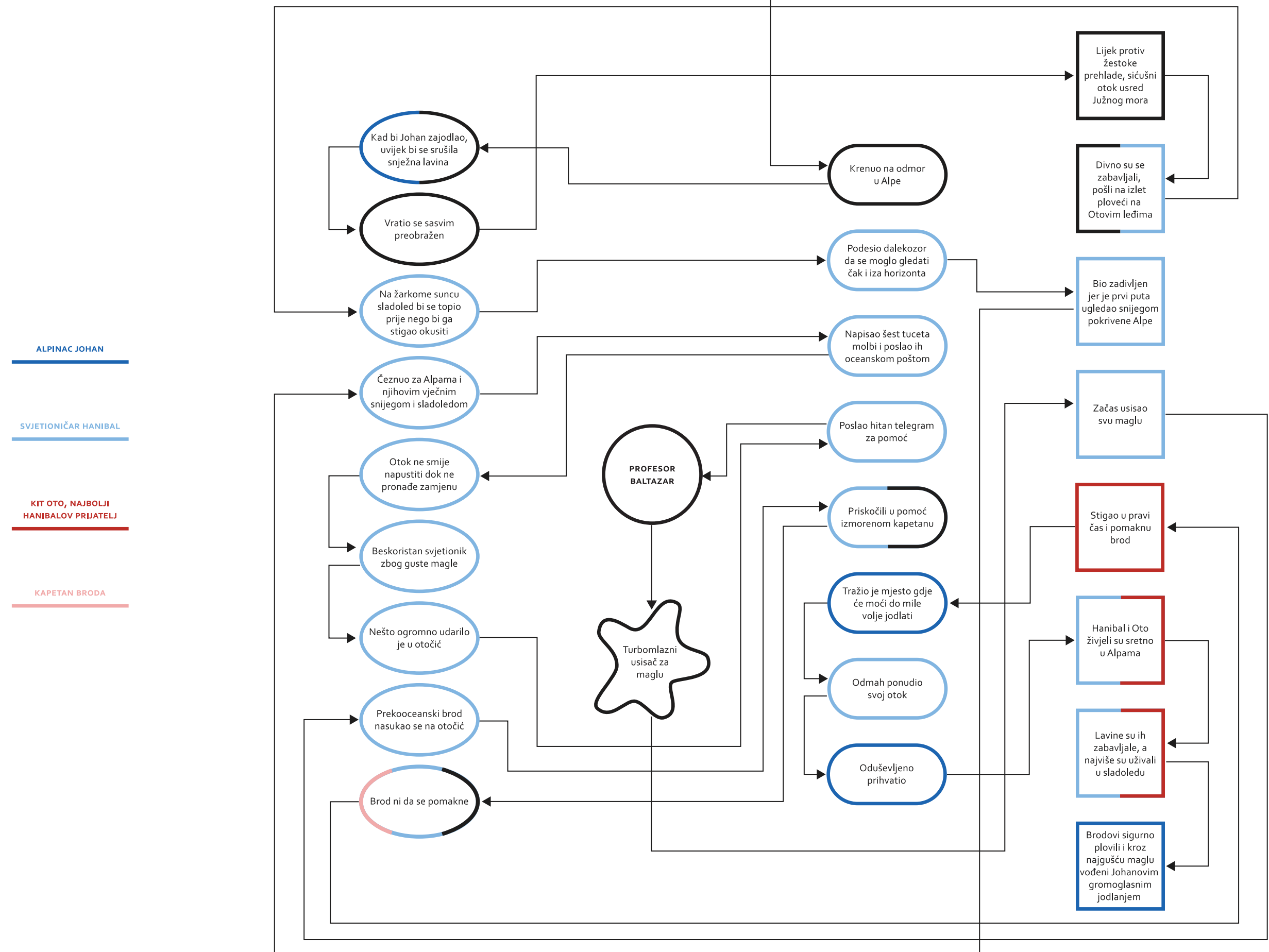

03 Horacijev uspon i pad

SVJETSKI SLAVAN
DIRIGENT HORACIJE

ŽIVOTINJSKI ZBOR

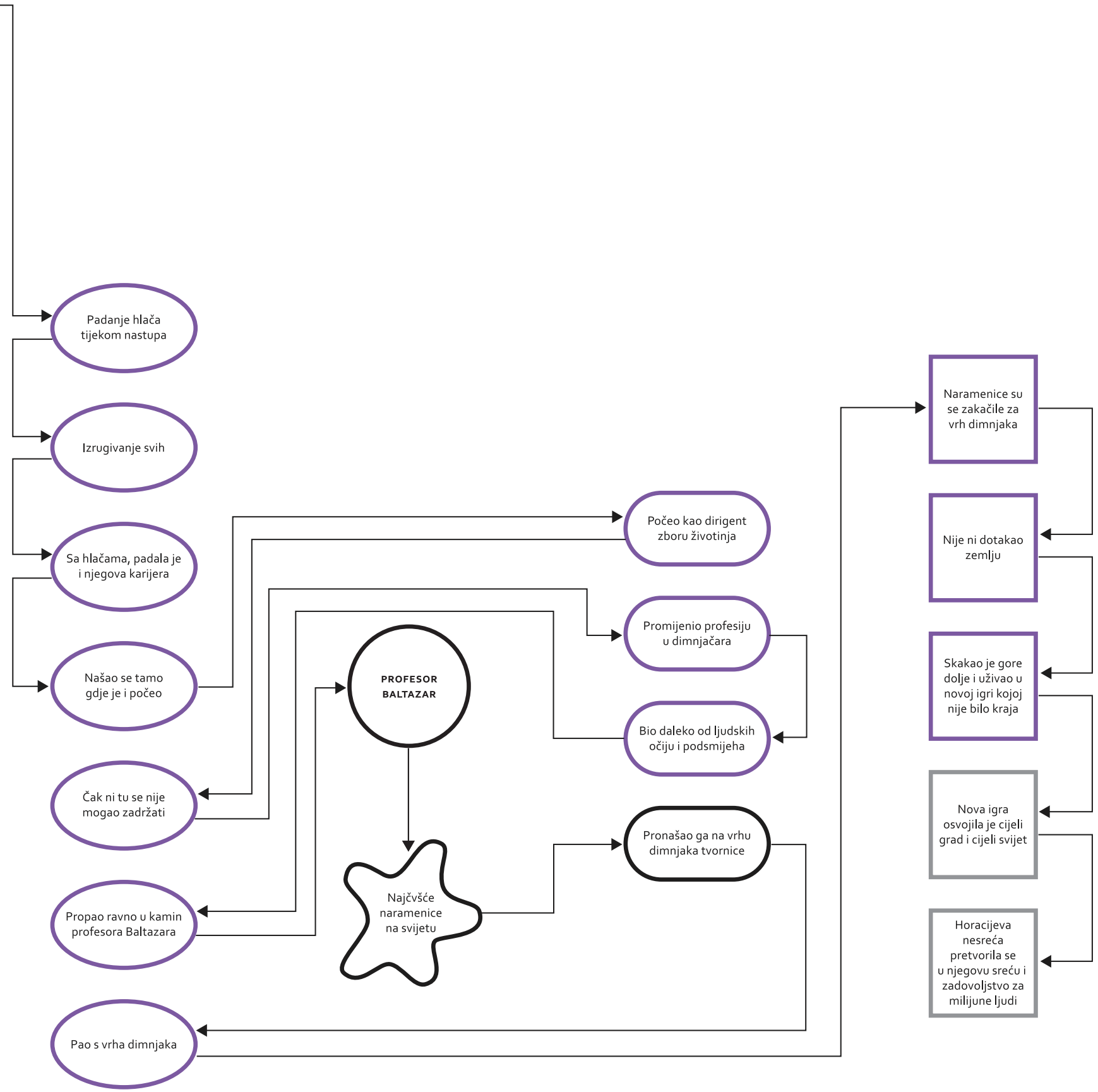

04 Leteći Fabijan

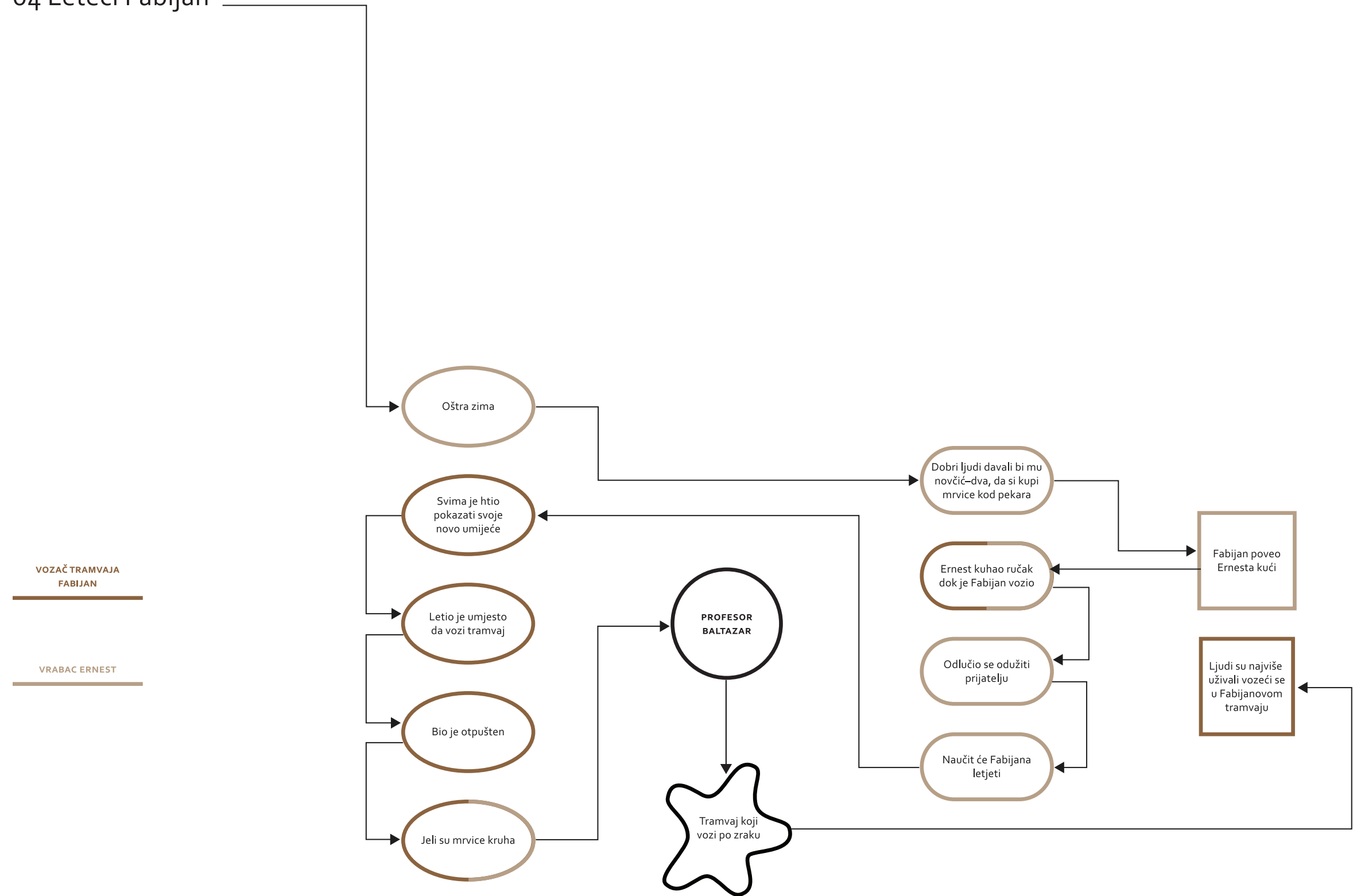

VOZAČ TRAMVAJA
FABIJAN

VRABAC ERNEST

05 Maestro Koko

SLON MAESTRO KOKO

FILIP, KOKOV
NAJBOLJI PRIJATELJ

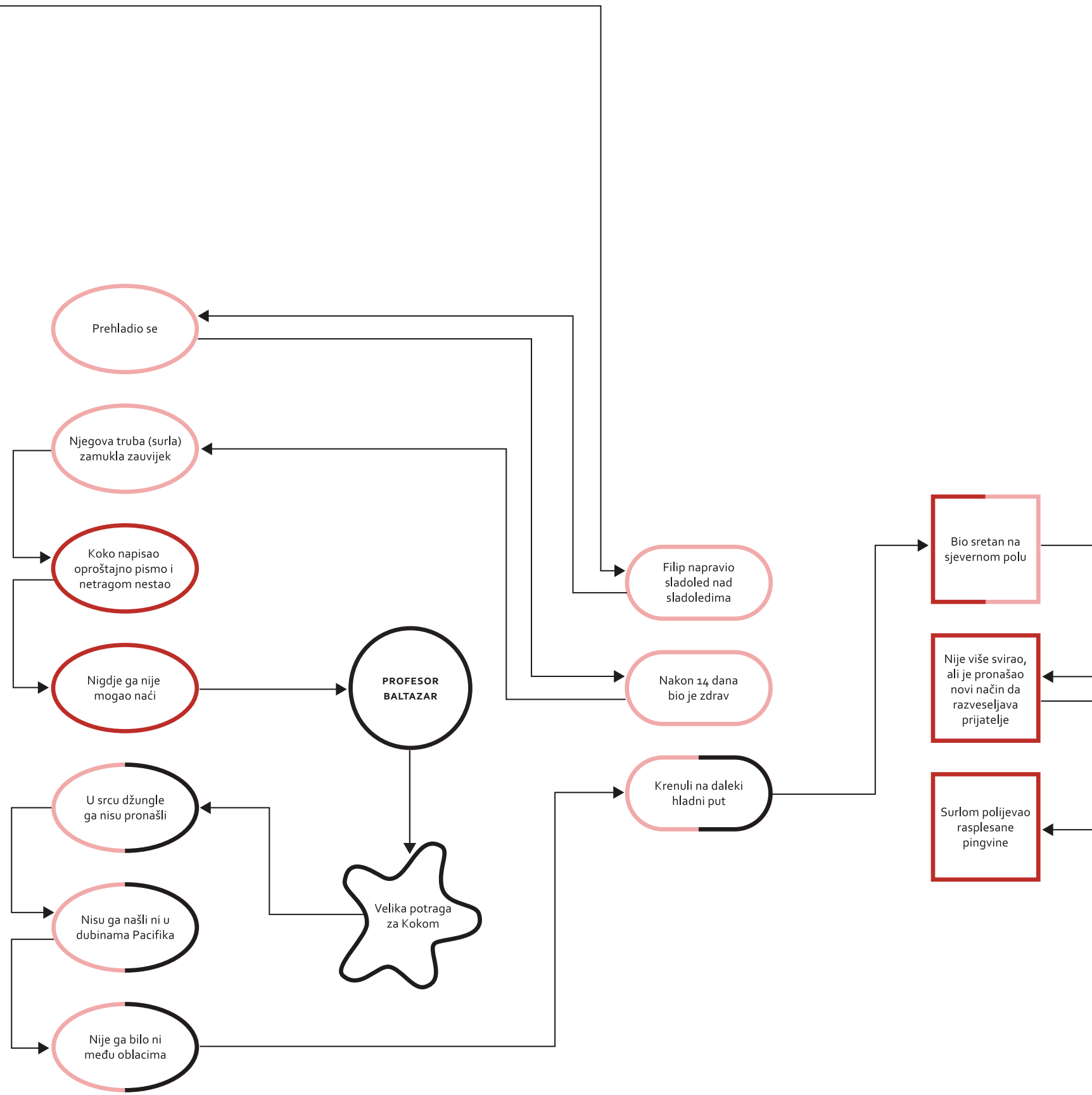

o6 Martin na vrhu

- MARTIN
- GRAĐANI BALTAZARGRADA
- GRADSKA SKUPŠTINA

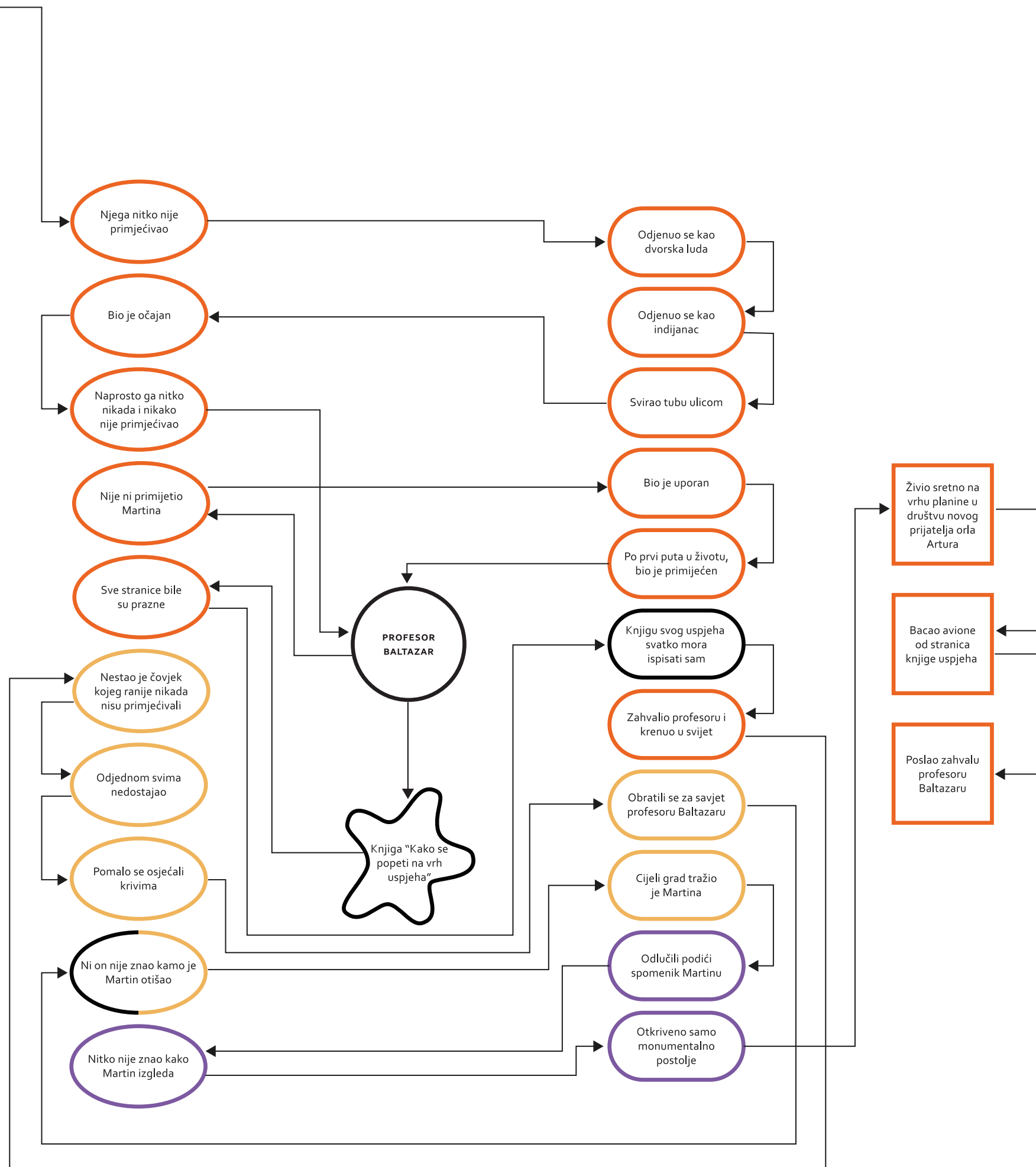

07 O mišu i satovima

- URAR OSCAR, NAJVJEŠTIJI URAR NA SVIJETU
- MIŠ IGOR
- PREDSTAVNICI ENGLJSKE VLADE

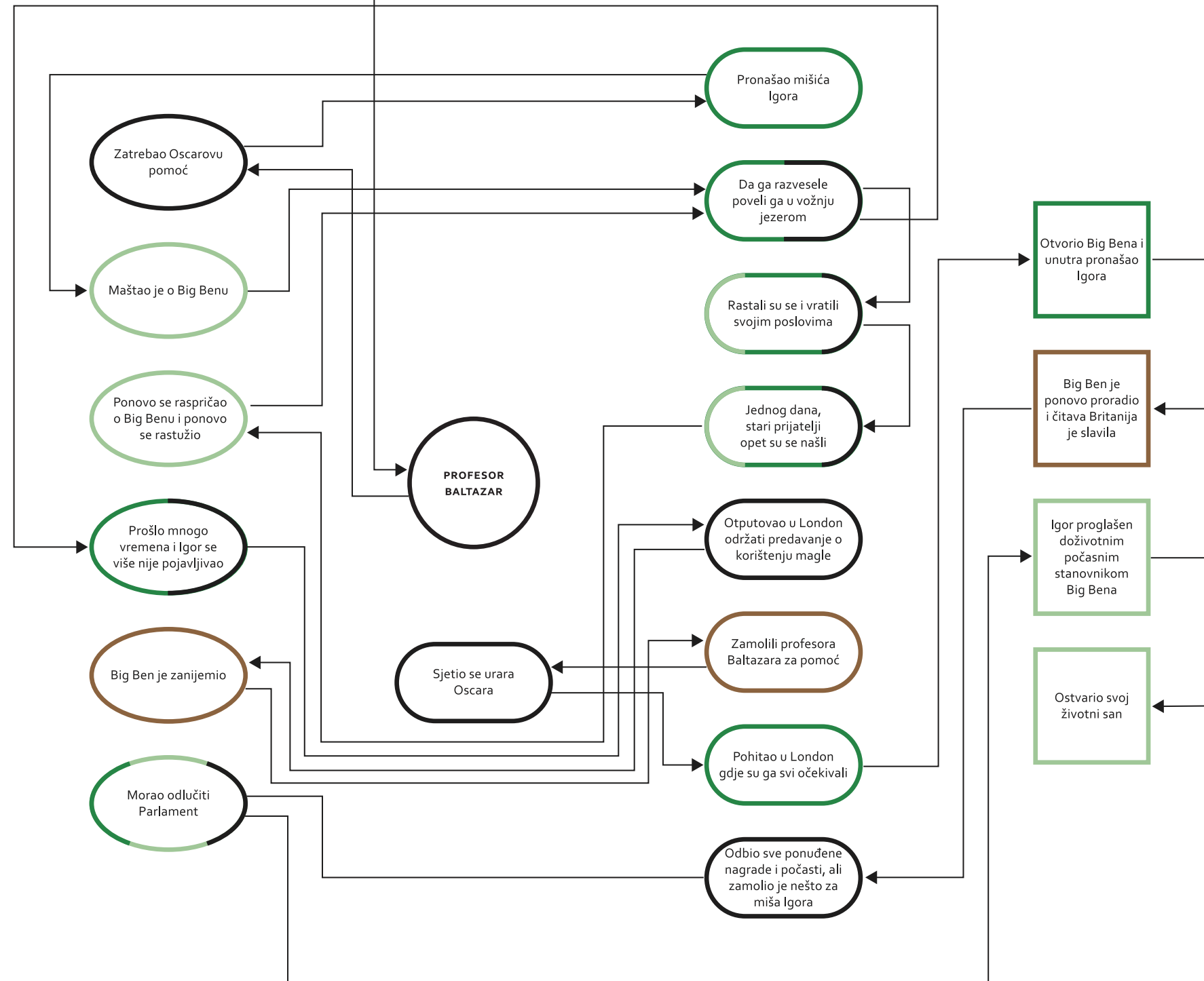

o8 Rođendanska priča

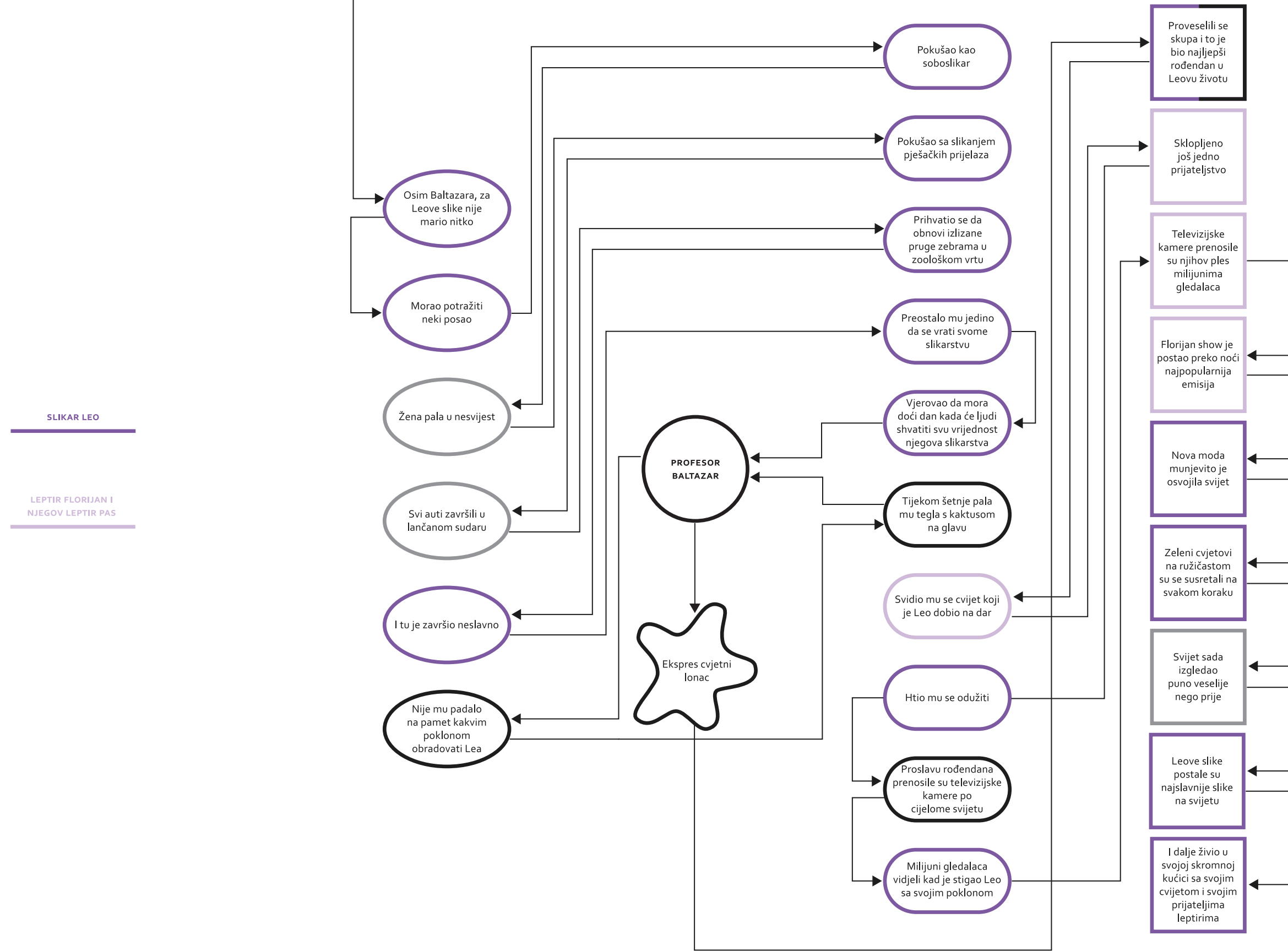

og Sreća u dvoje

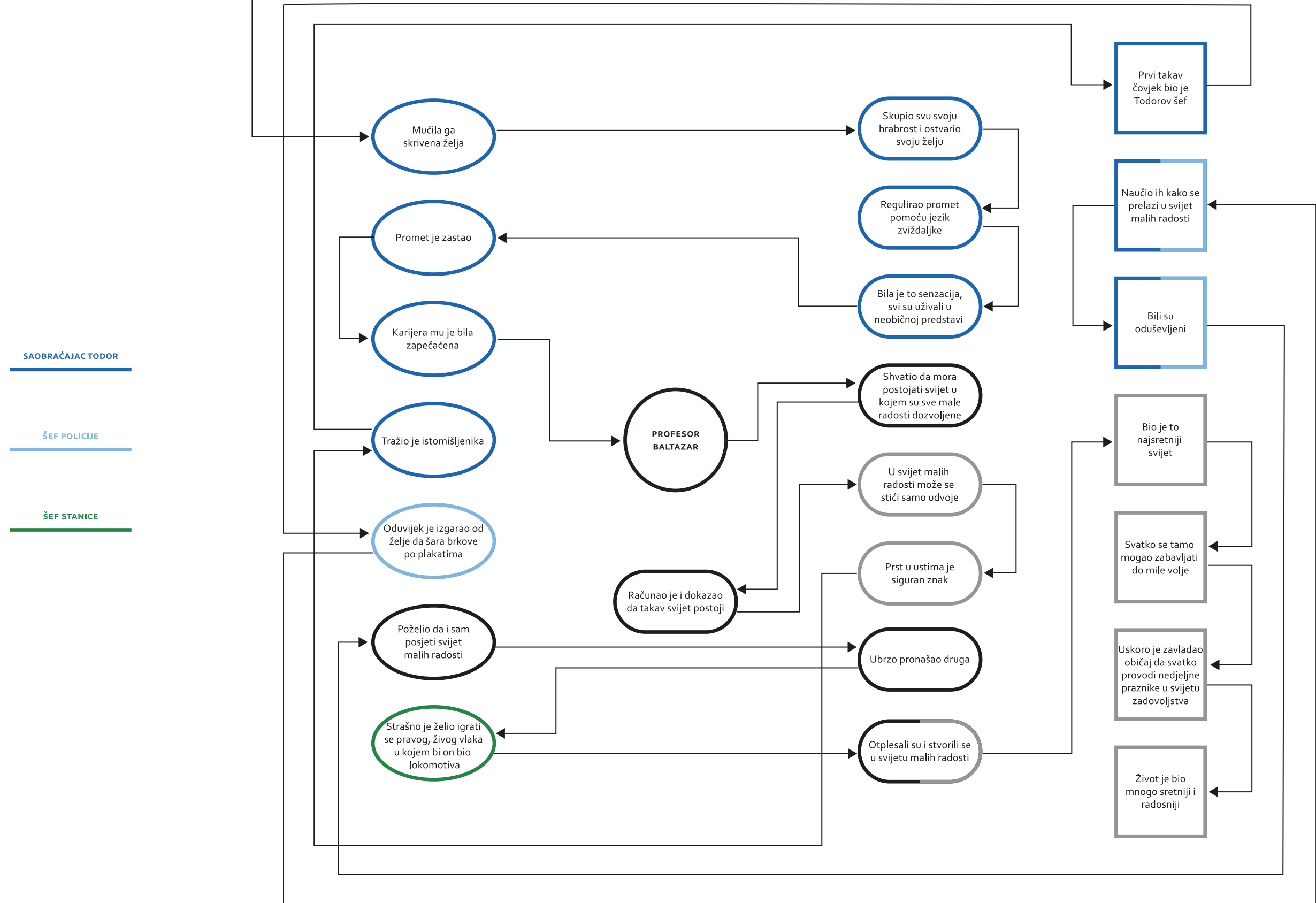

10 Tetke pletke

- TETKA KLOTILDA
- PAS BOB
- TETKA MATILDA
- MAČKA MIMI
- KVARTET OKTAVIJAN, HOBOTNICA
- OKTOPODI

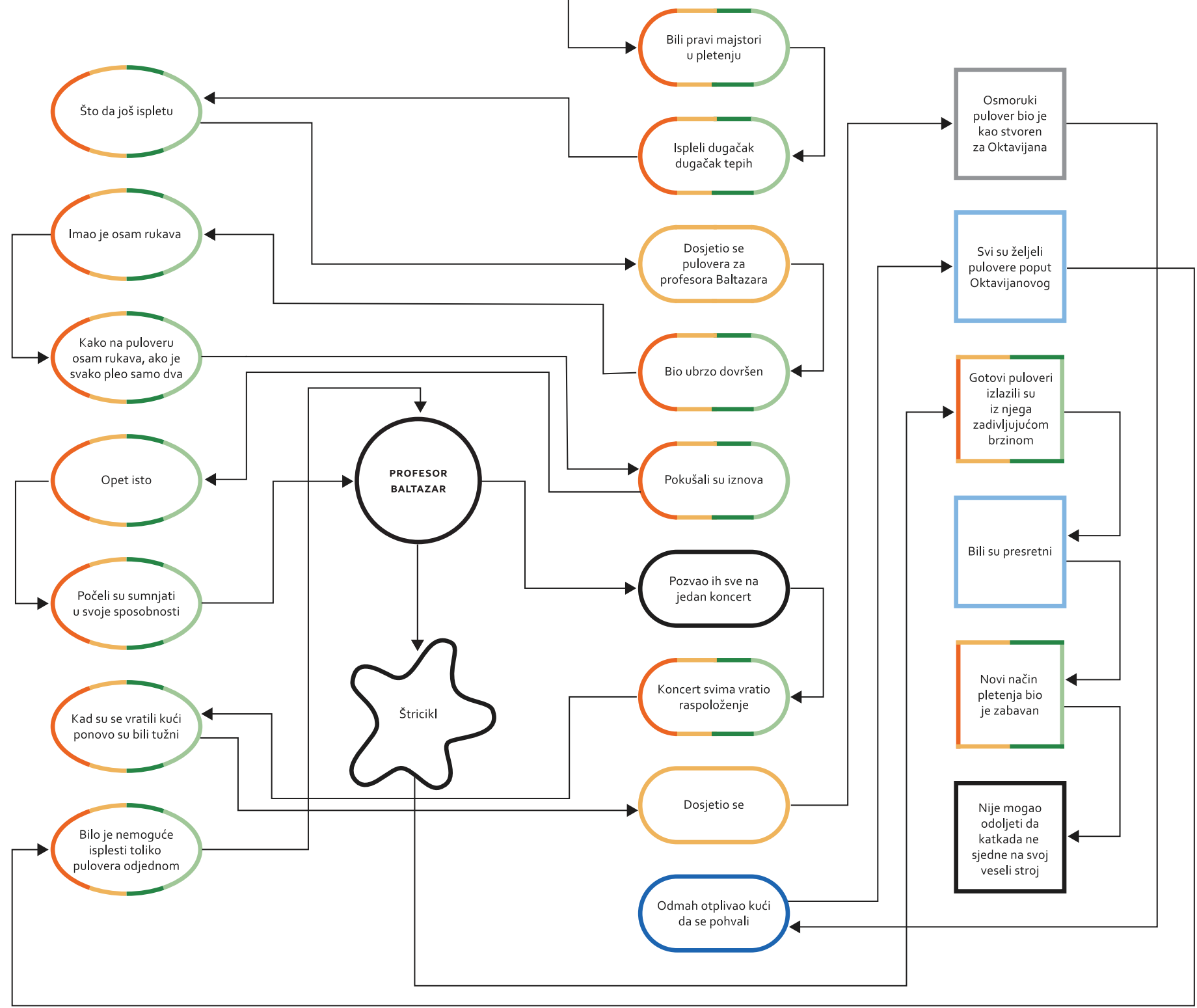

11 Viktorov jajomat

- VIKTOR
- KOLPORTER MARIO
- DIZALIČAR TOMA
- KAPETAN FILIBERT
- IGNAC
- URAR OSCAR
- BESKUĆNIK ALFONZ
- PENZIONIRANI ADMIRAL SILVESTAR
- GRAĐANI
- ZIZI

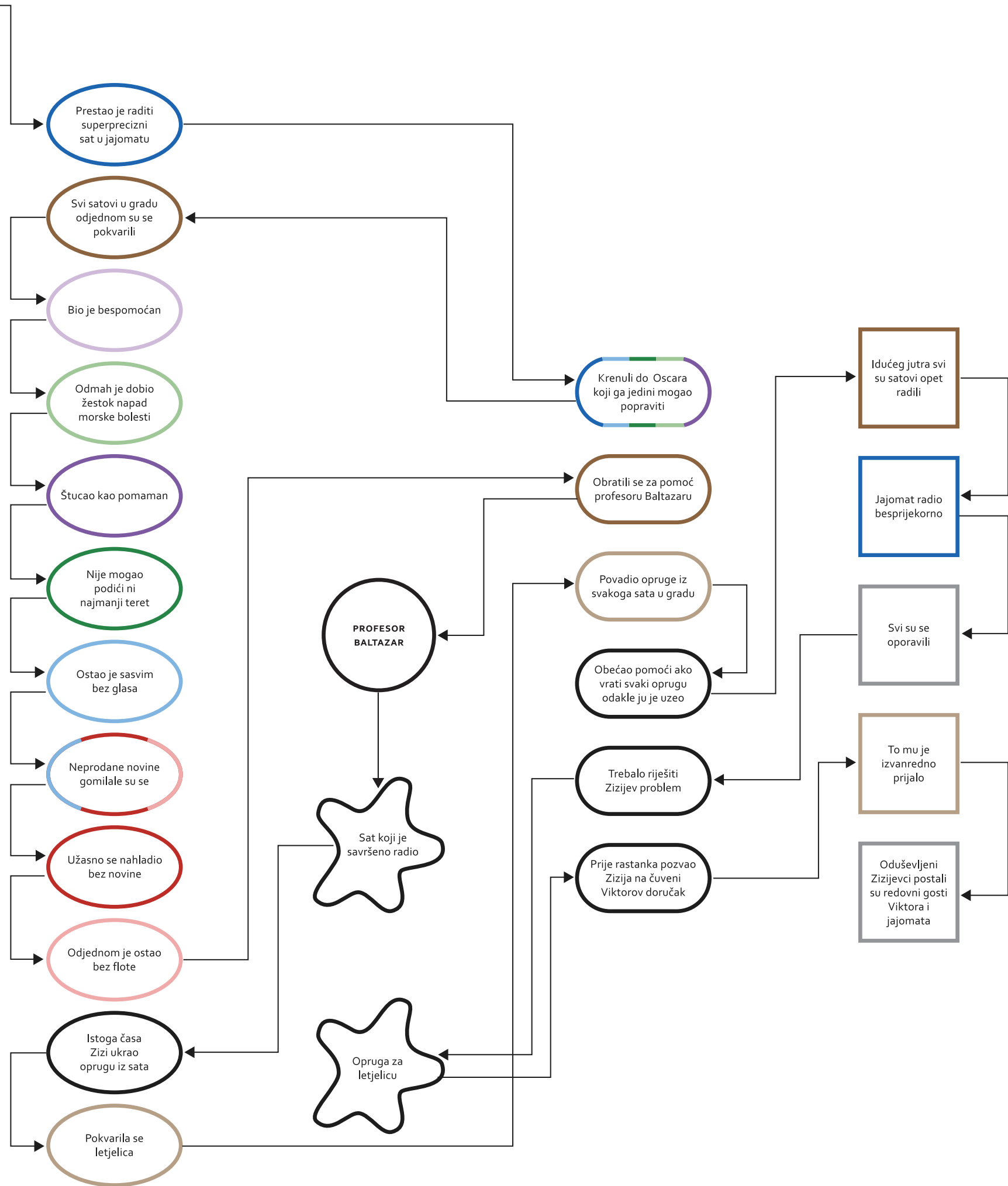

12 Vjetrovita priča

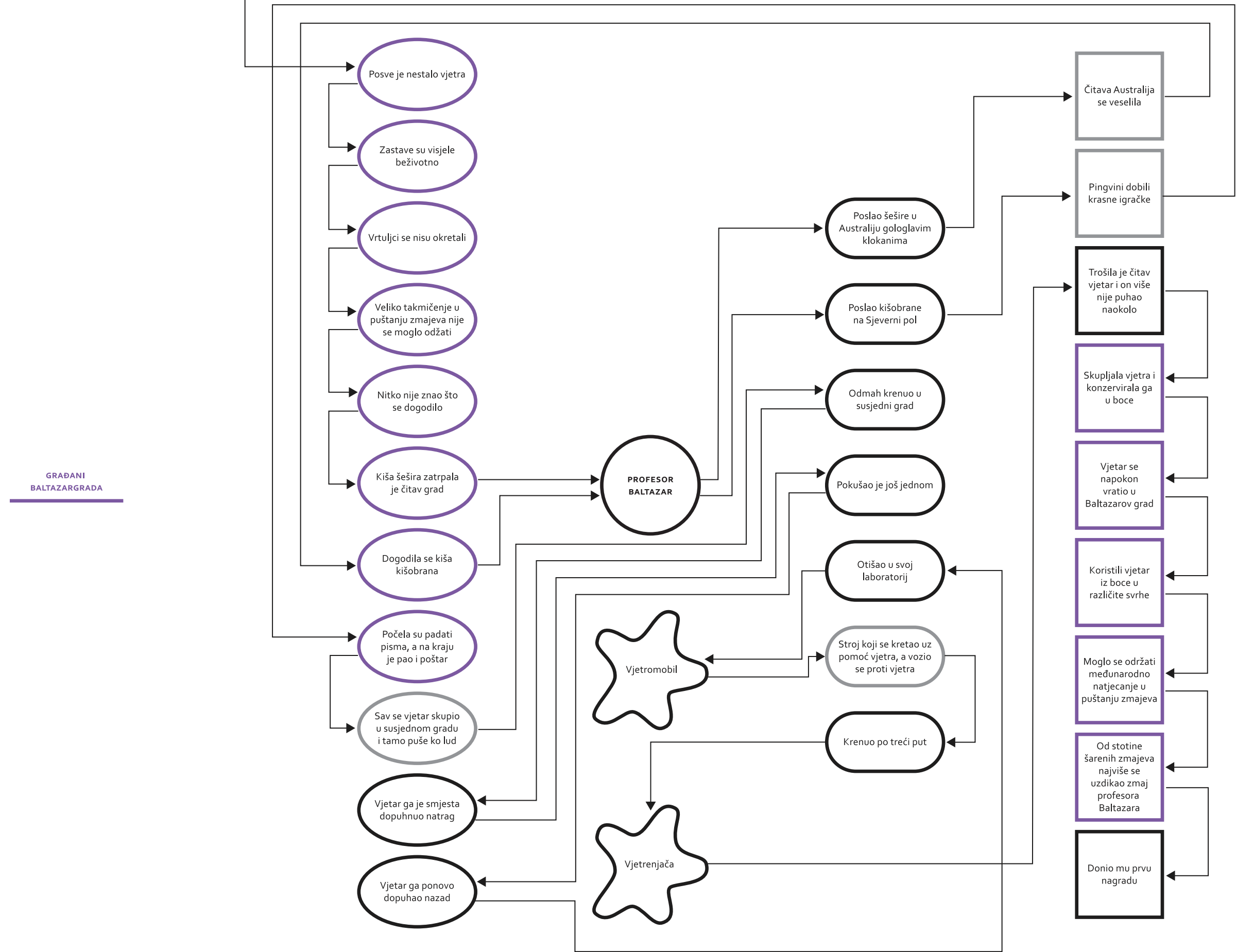

13 Zvezdani kvartet

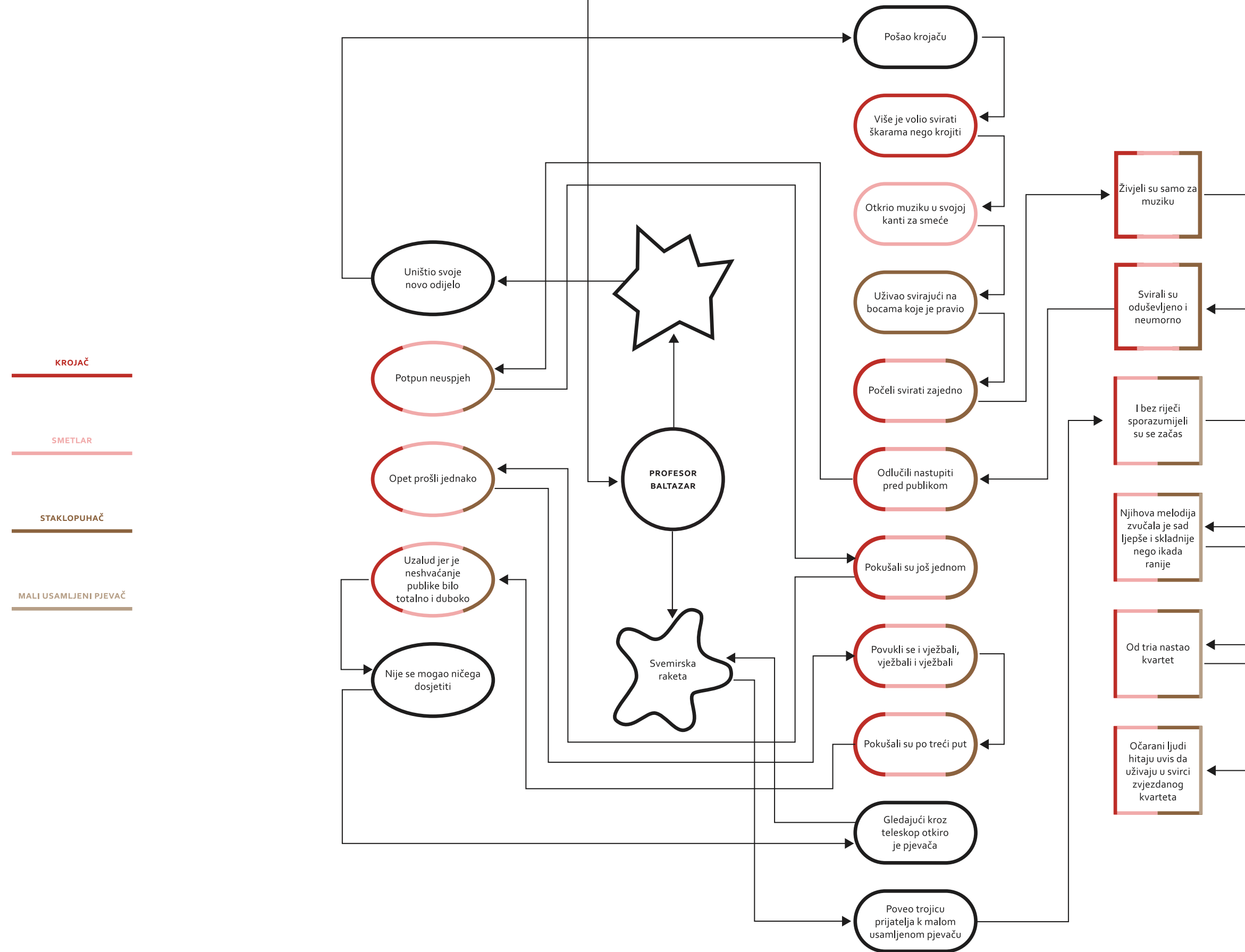

01 Alfred noćni čuvar

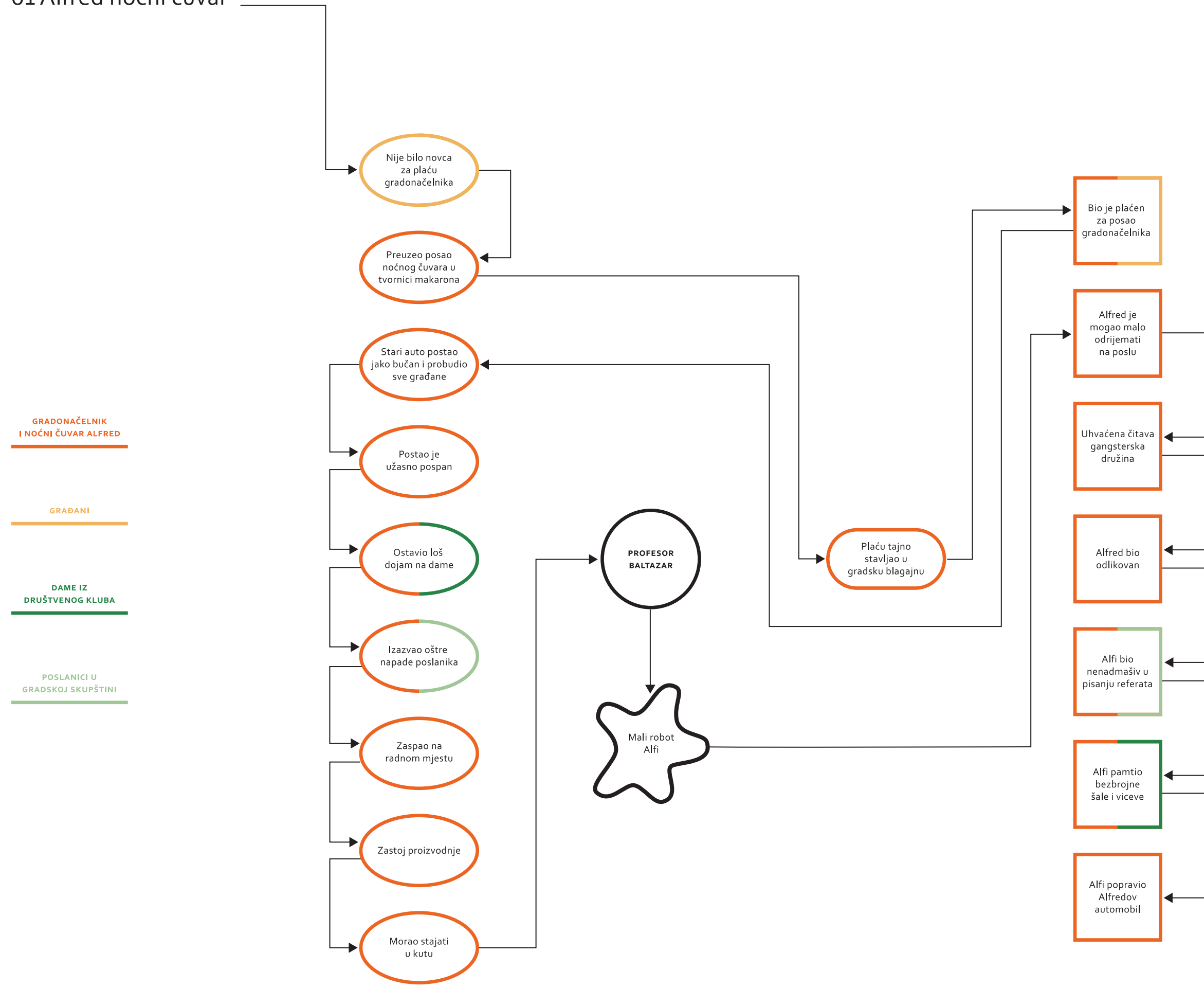

02 Bim–Bum

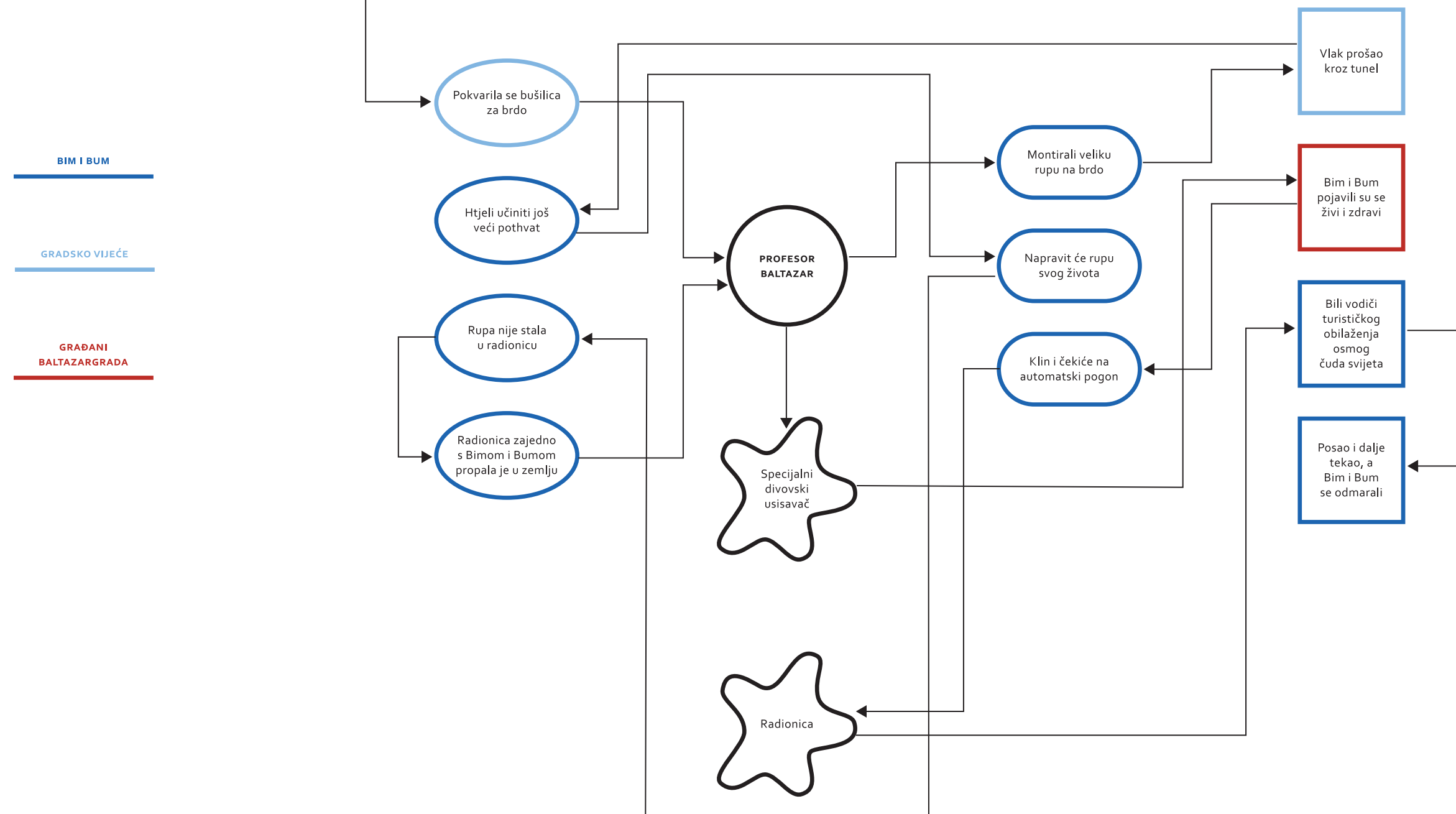

03 Čudotvorni kolač

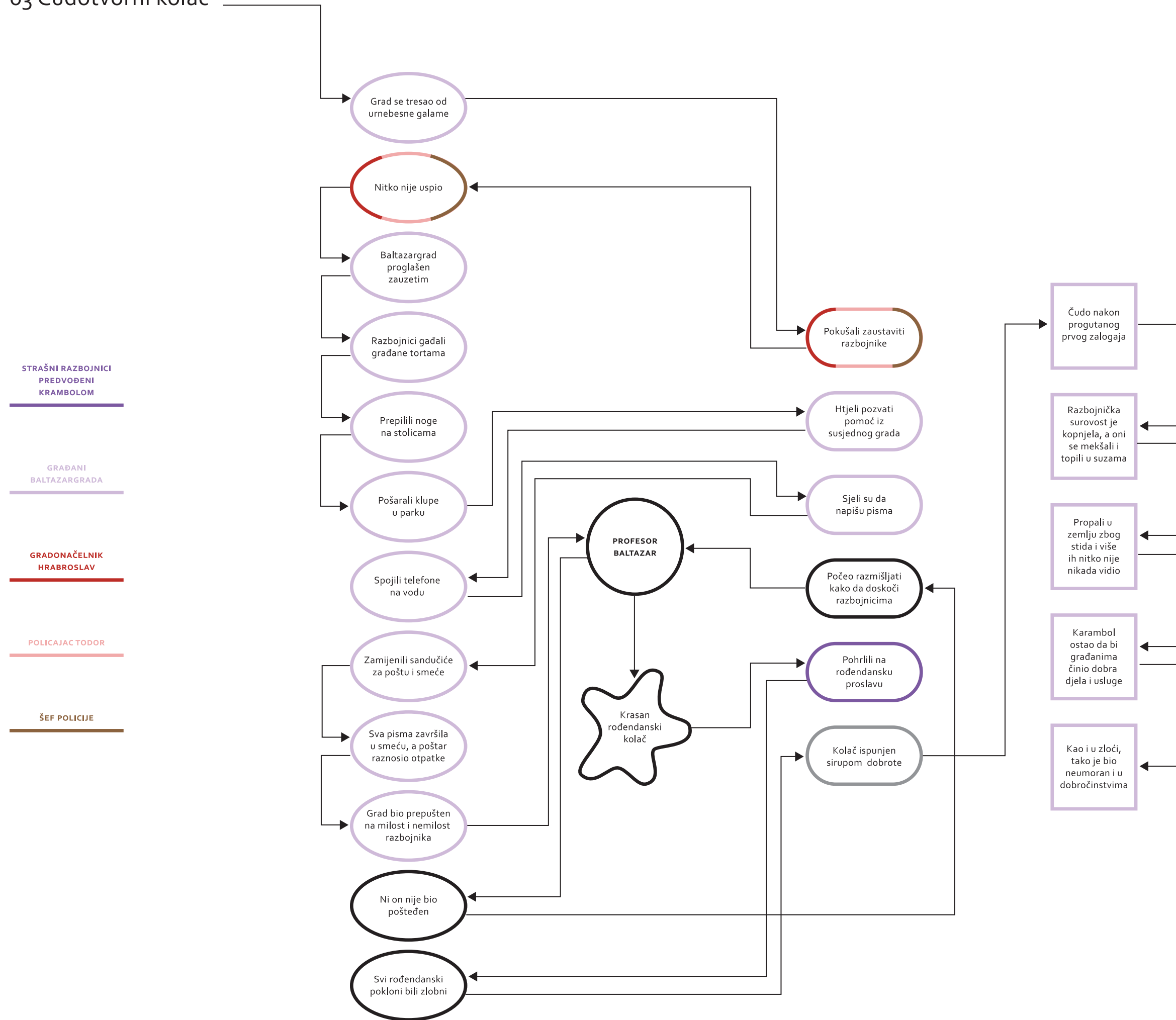

04 Doktor za životinje

- TOMOV TATA, DOKTOR ZA ŽIVOTINJE
- TOM
- DEVA ABDULAH
- MEDVJED ARCHIE
- TIGAR VILI
- KROKODIL STANLEY
- SLON KOKO
- LAV MIKE
- ZOO ČUVARI

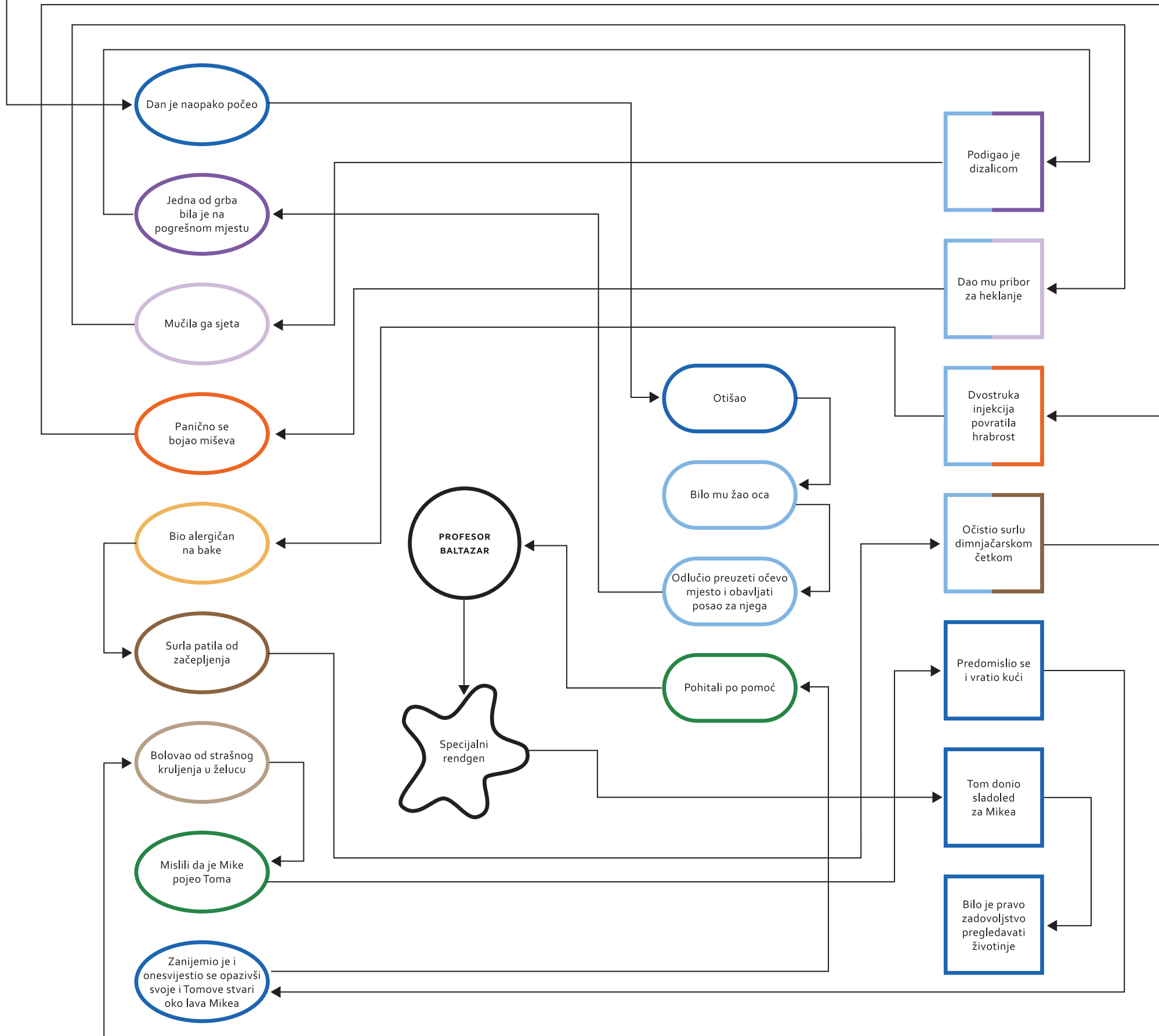

05 Duga Profesora Baltazara

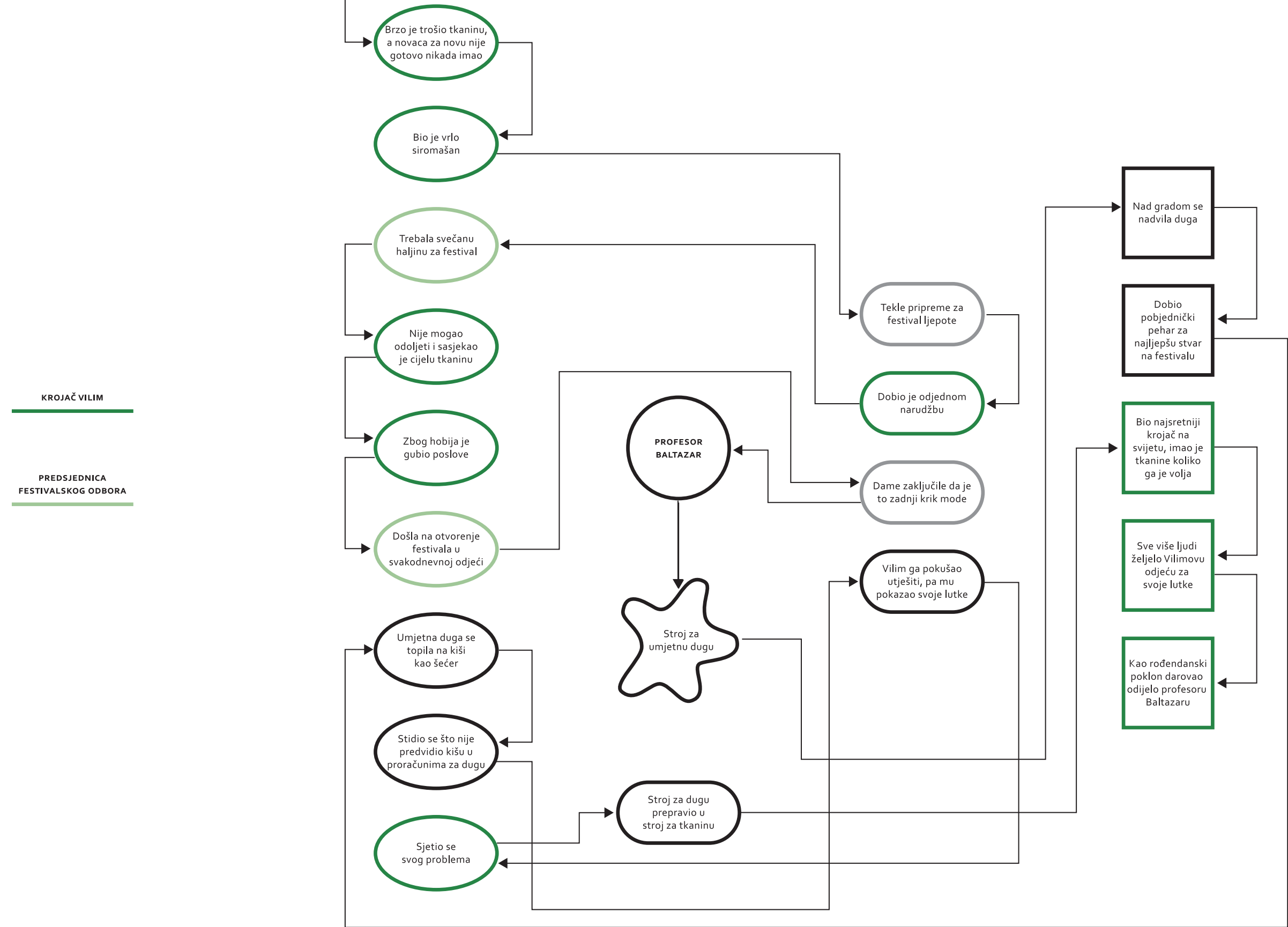

o6 Fiharo Hop

- MLINAR MARTIN I MLINARICA MARTA
- GRAĐANI BALTAZARGRADA
- ŽABAC FIGARO

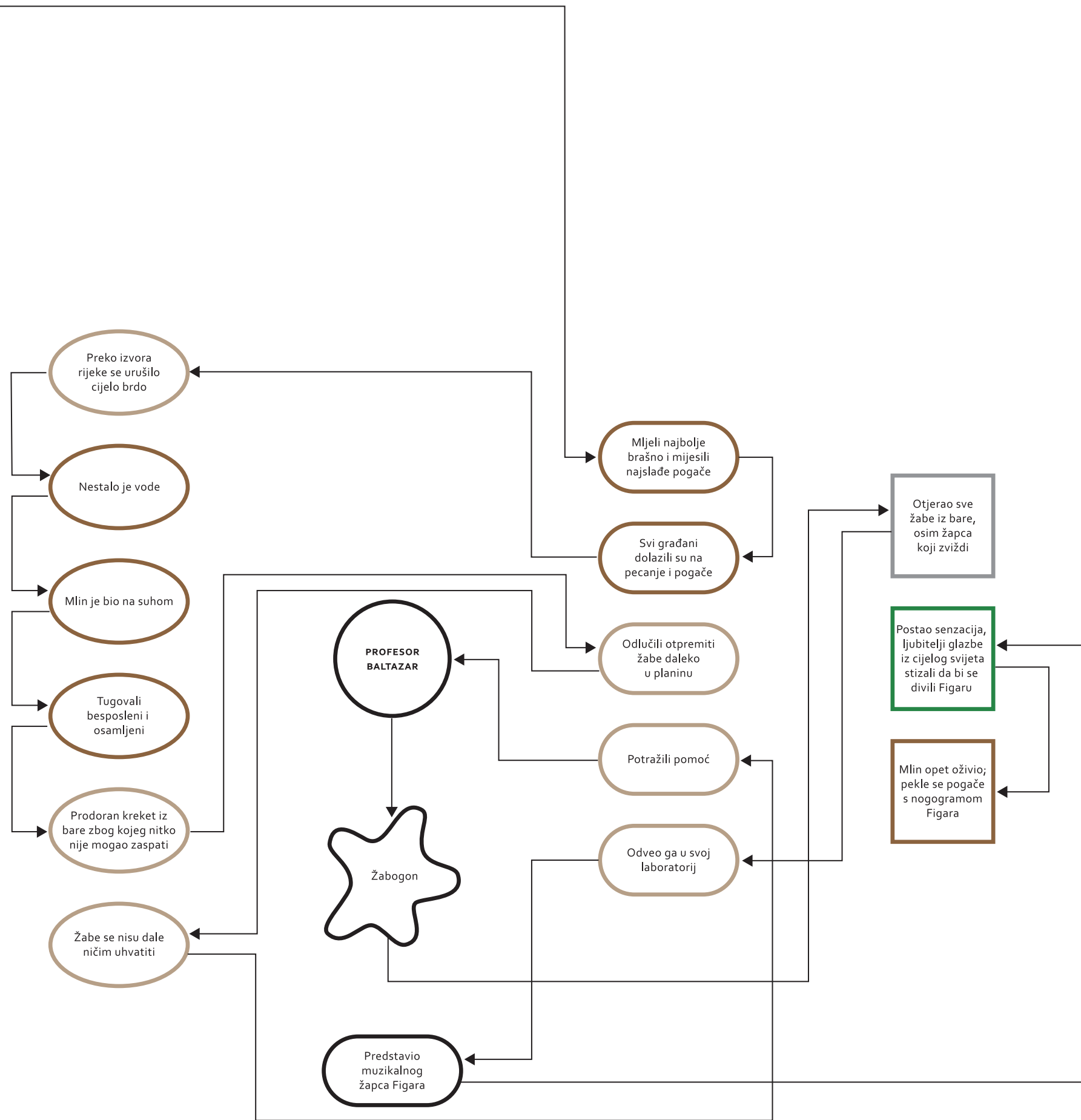

07 Krojač Silvestar

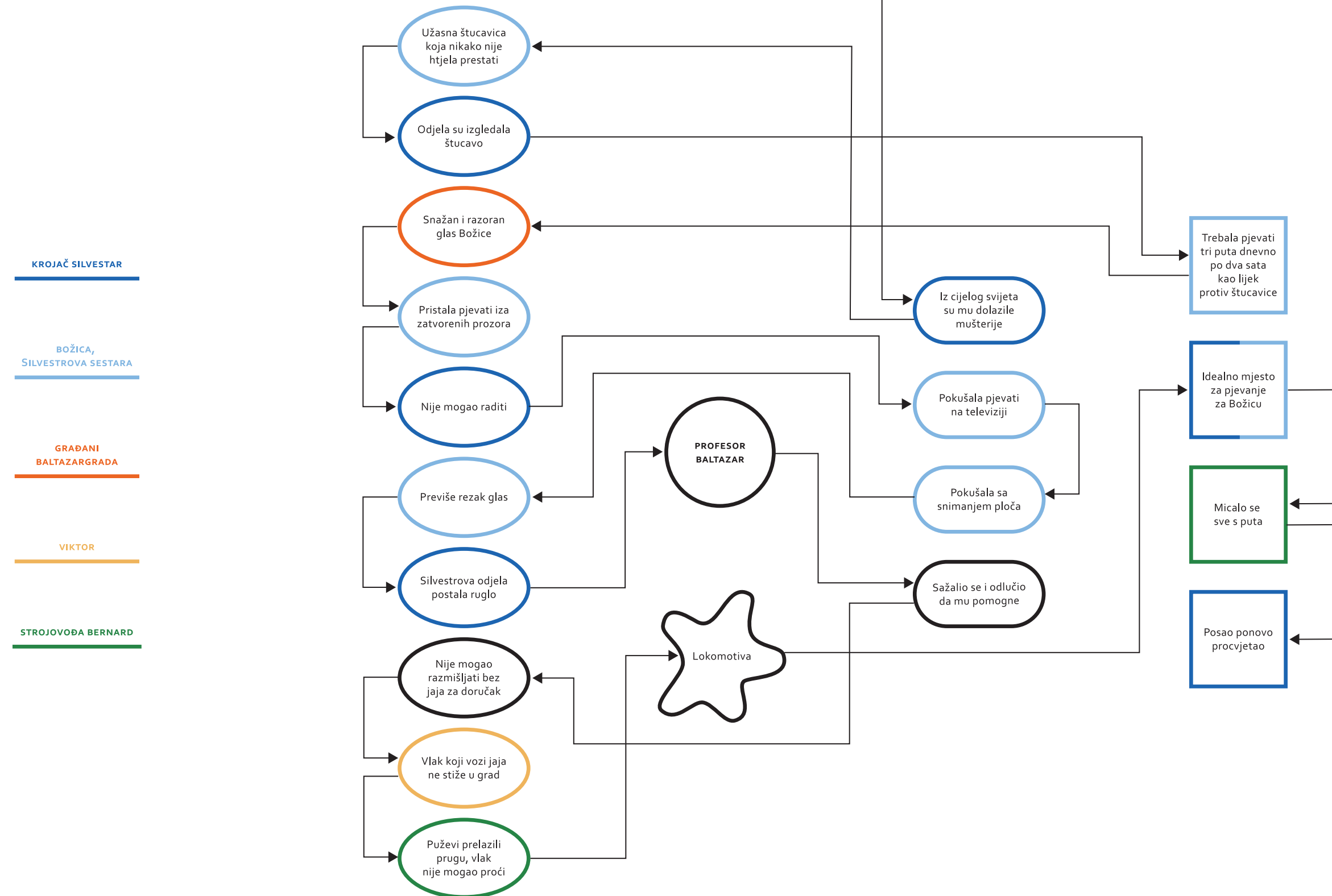

o8 Ledeno vruće

HANS, GRADONAČELNIK I PRIJATELJ IZ DJETINJSTVA PROFESORA BALTAZARA

IVAN, PRIJATELJ IZ DJETINJSTVA PROFESORA BALTAZARA

POLARNI MEDVJEDI U ZOOLOŠKOM VRTU

GOSPOĐA GRADONAČELNIKOVICA

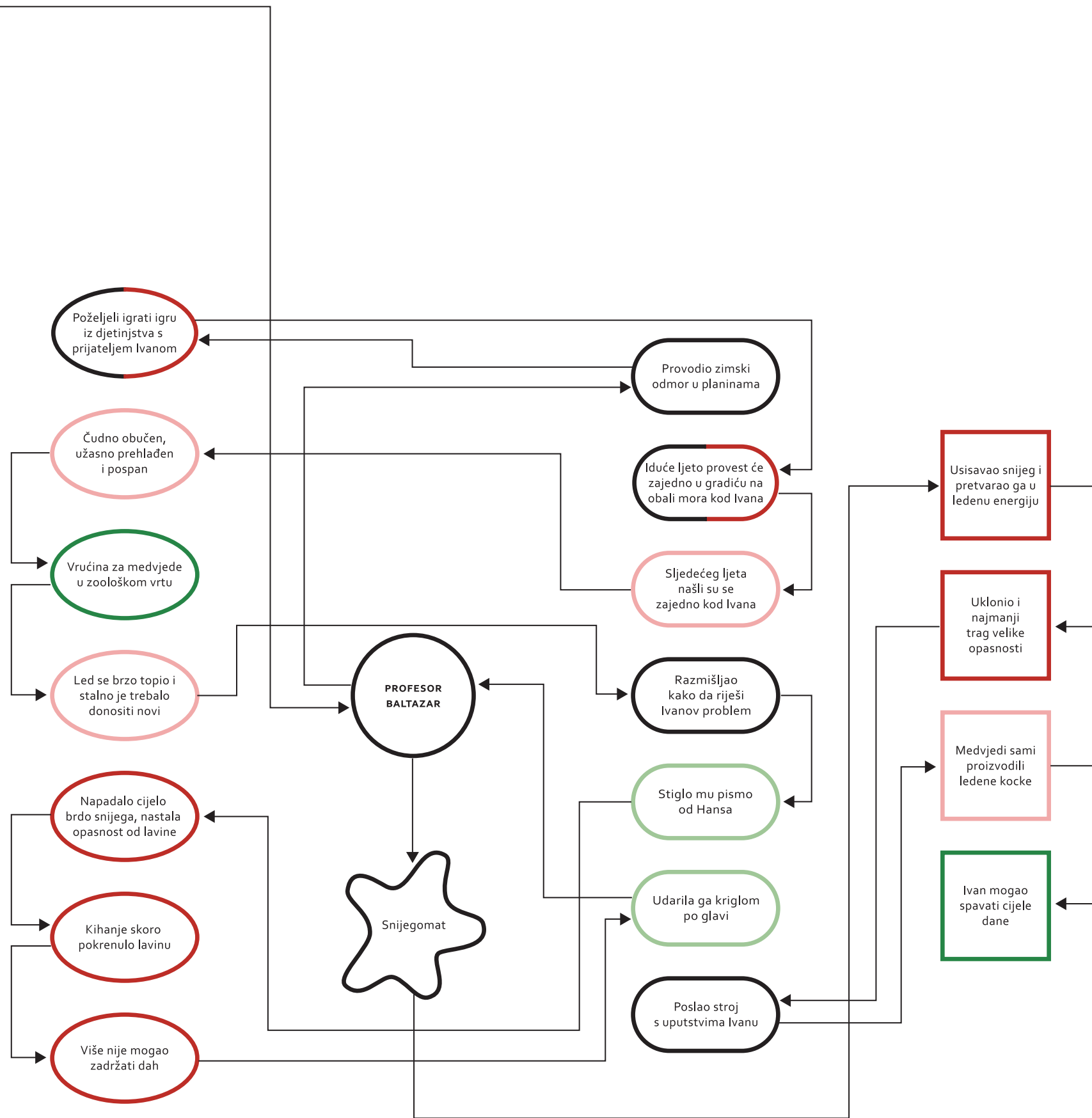

og Lutke bez kose

GRADANI
BALTAZARGRADA

HUKANCI, STANOVNICI
PLANETE HUK

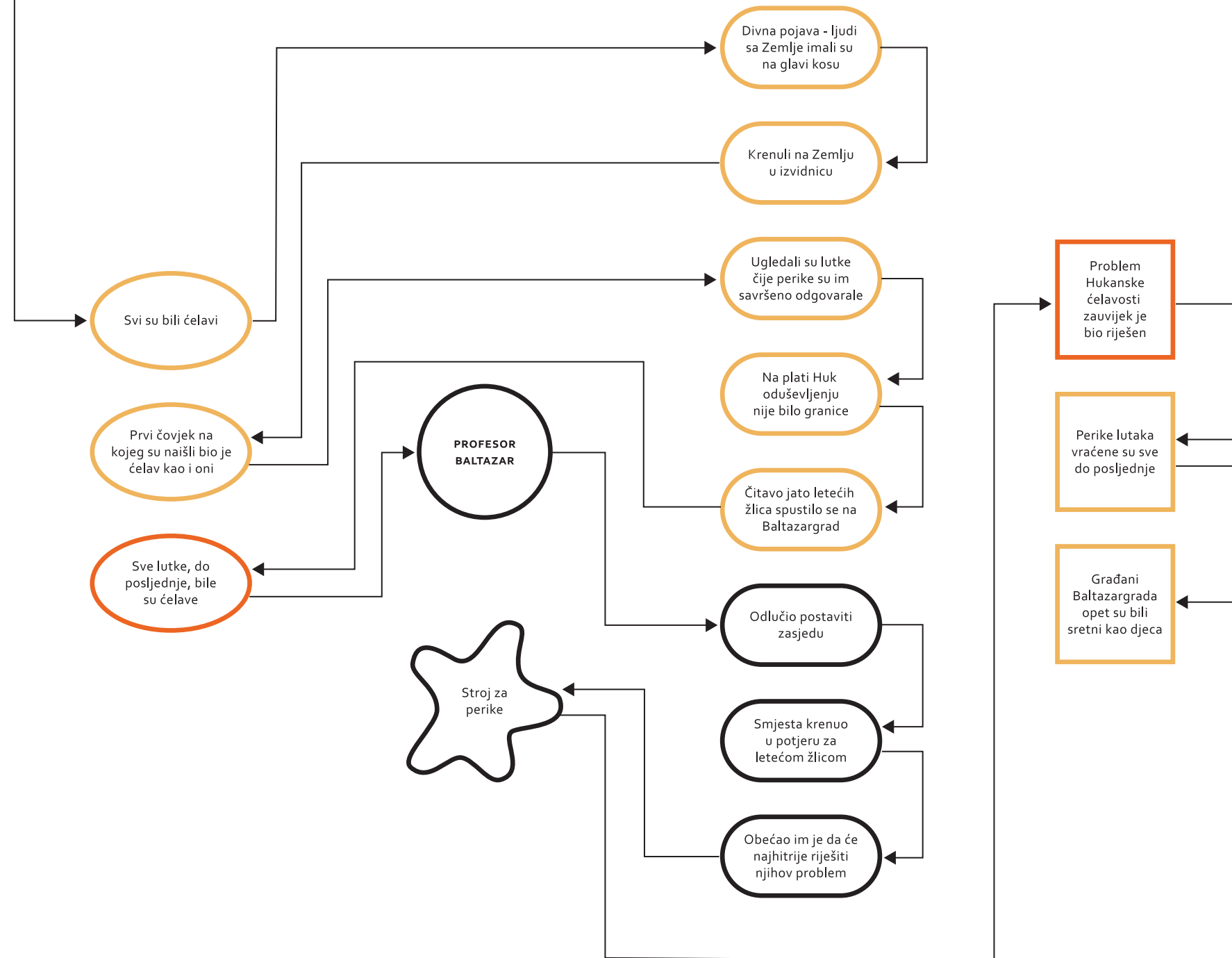

10 Oblačna priča

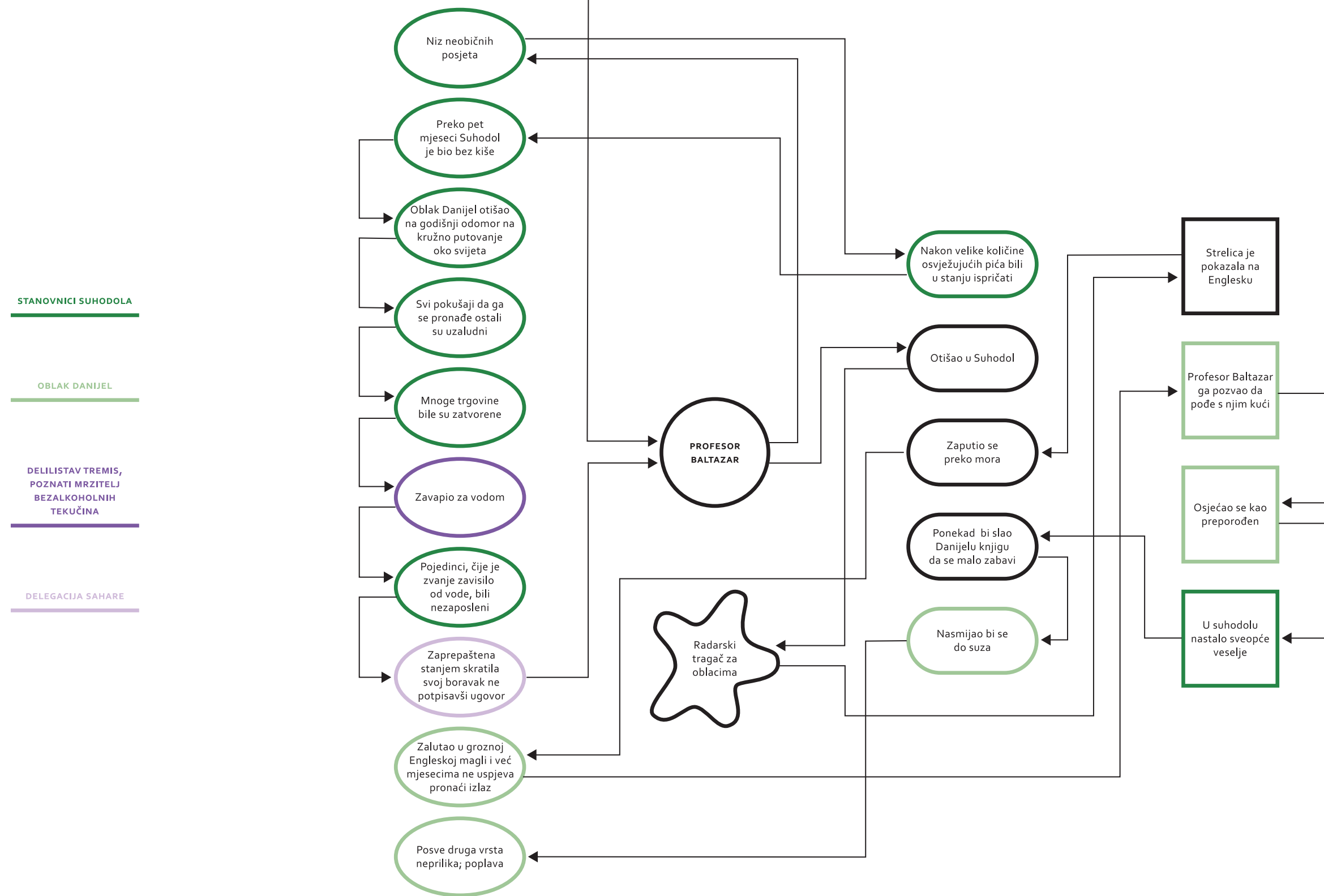

11 Problem nespretnosti

PEPI, NAJNESPREJNIJI
ČOVJEK NA SVIJETU

MEDVJEDI U ŠUMI

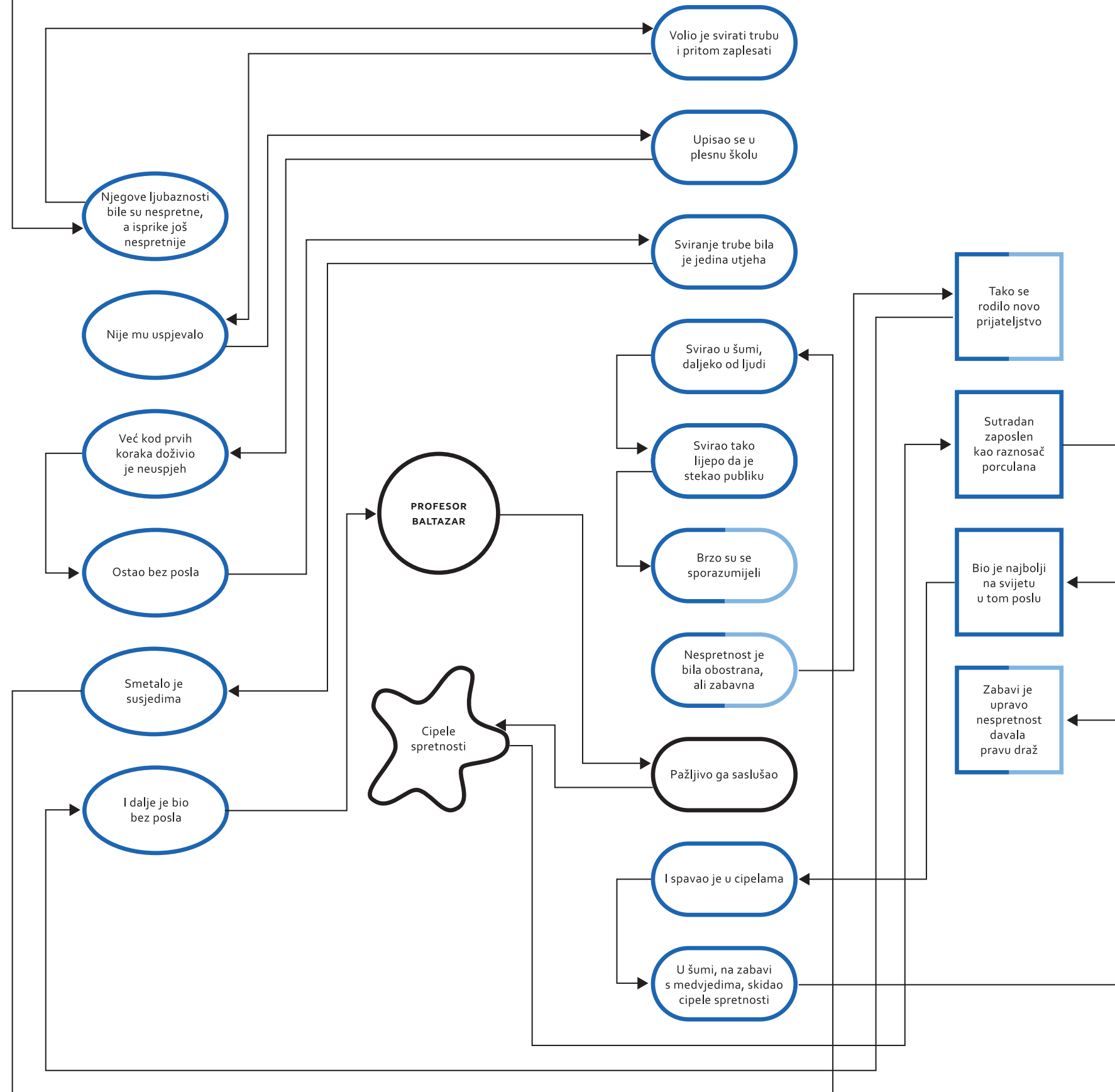

12 Zvonko sa zvonika

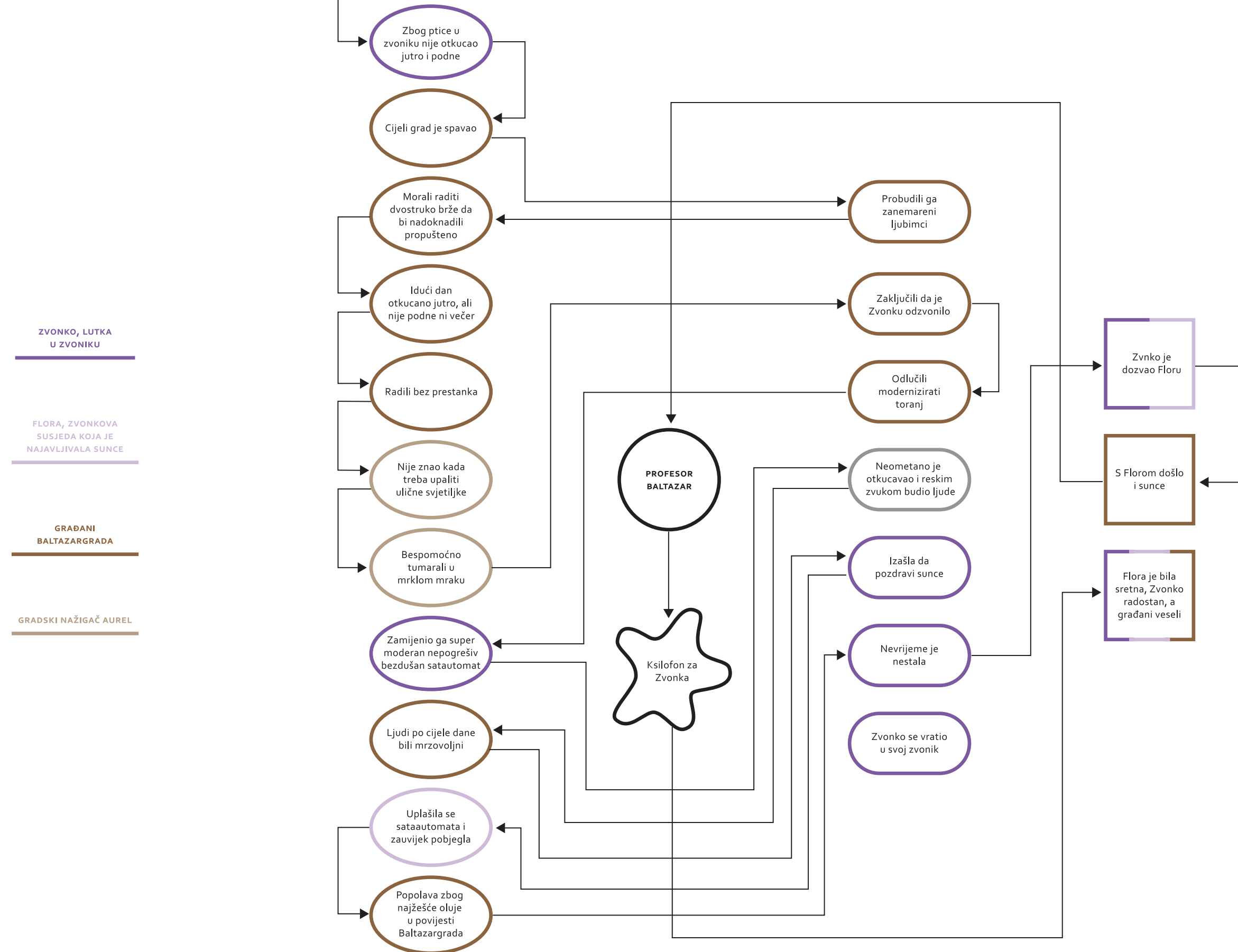

13 Najveći snjegović

GRADANI
BALTAZARGRADA

KAPETAN FILIBERT

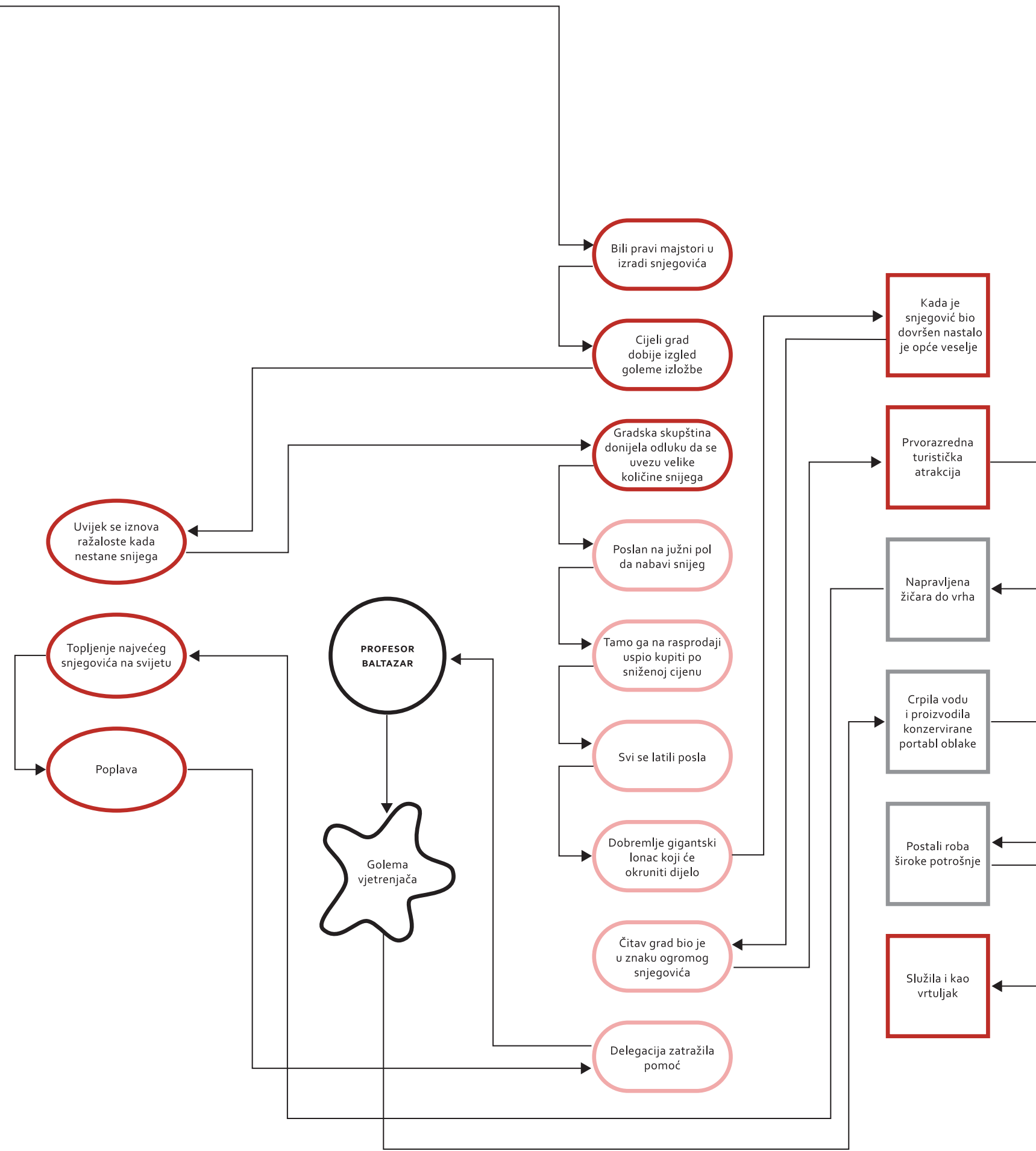

01 Amadeusove uši

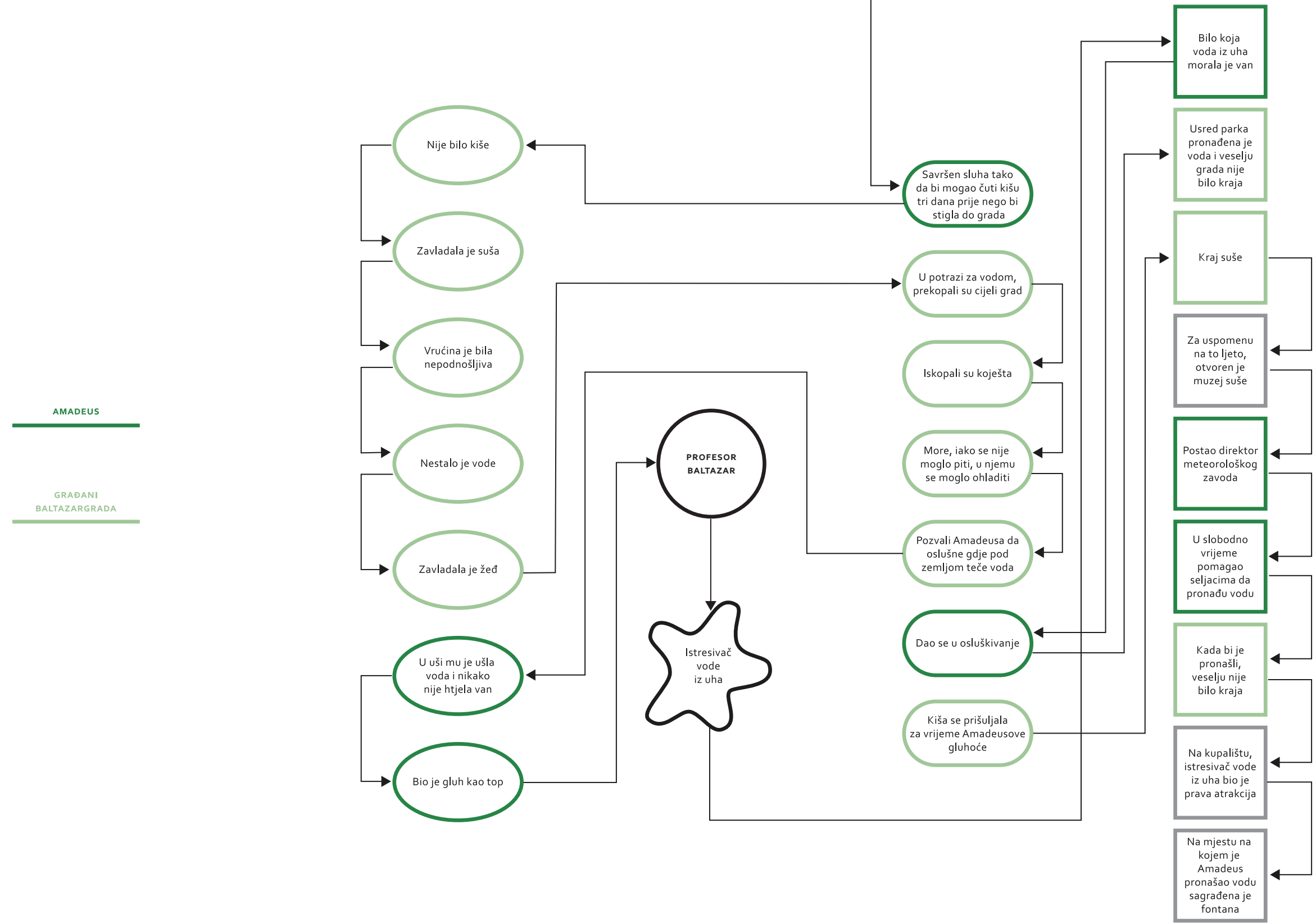

02 Drama oko cvijeća

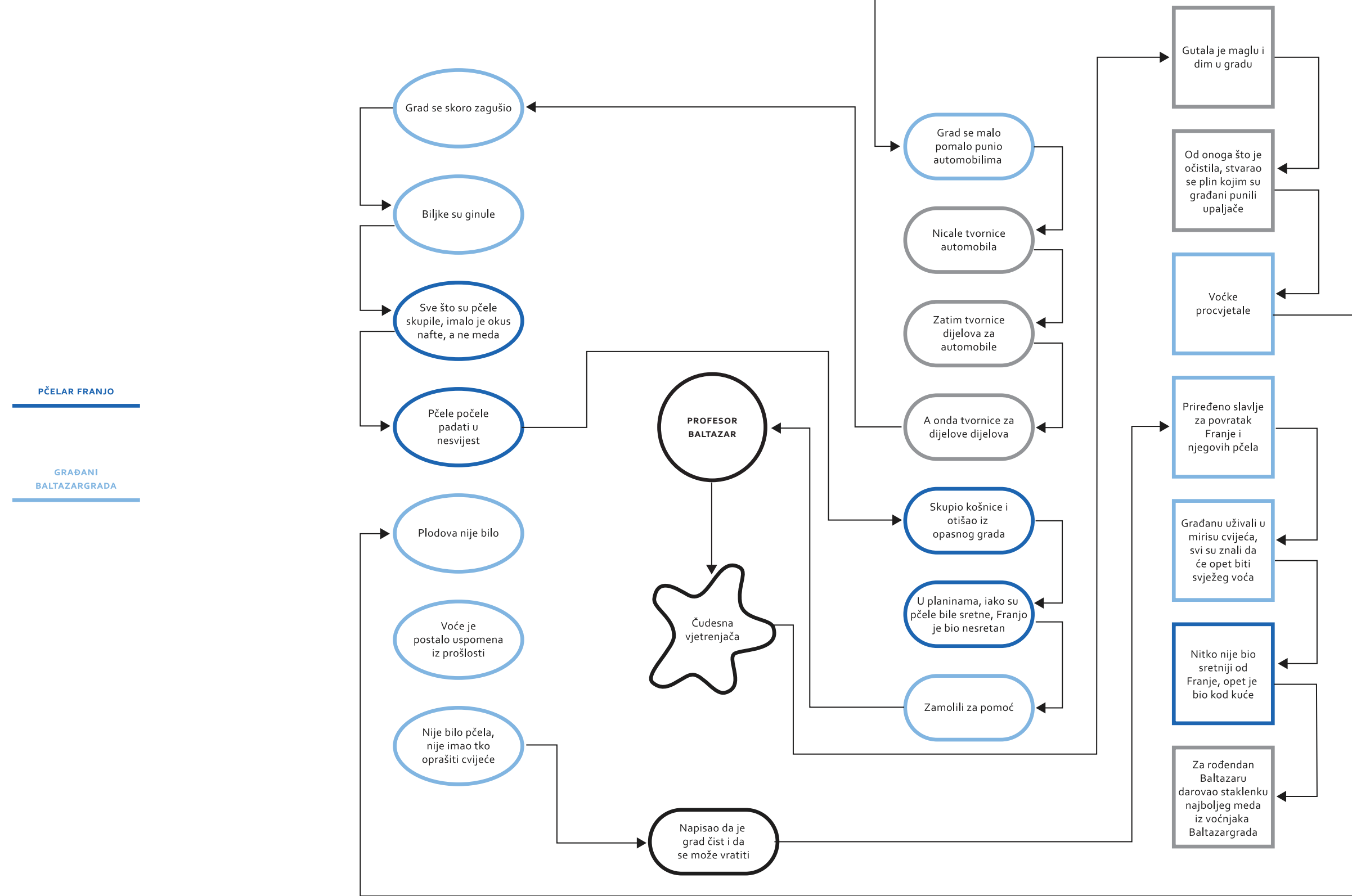

03 Gusarski problem

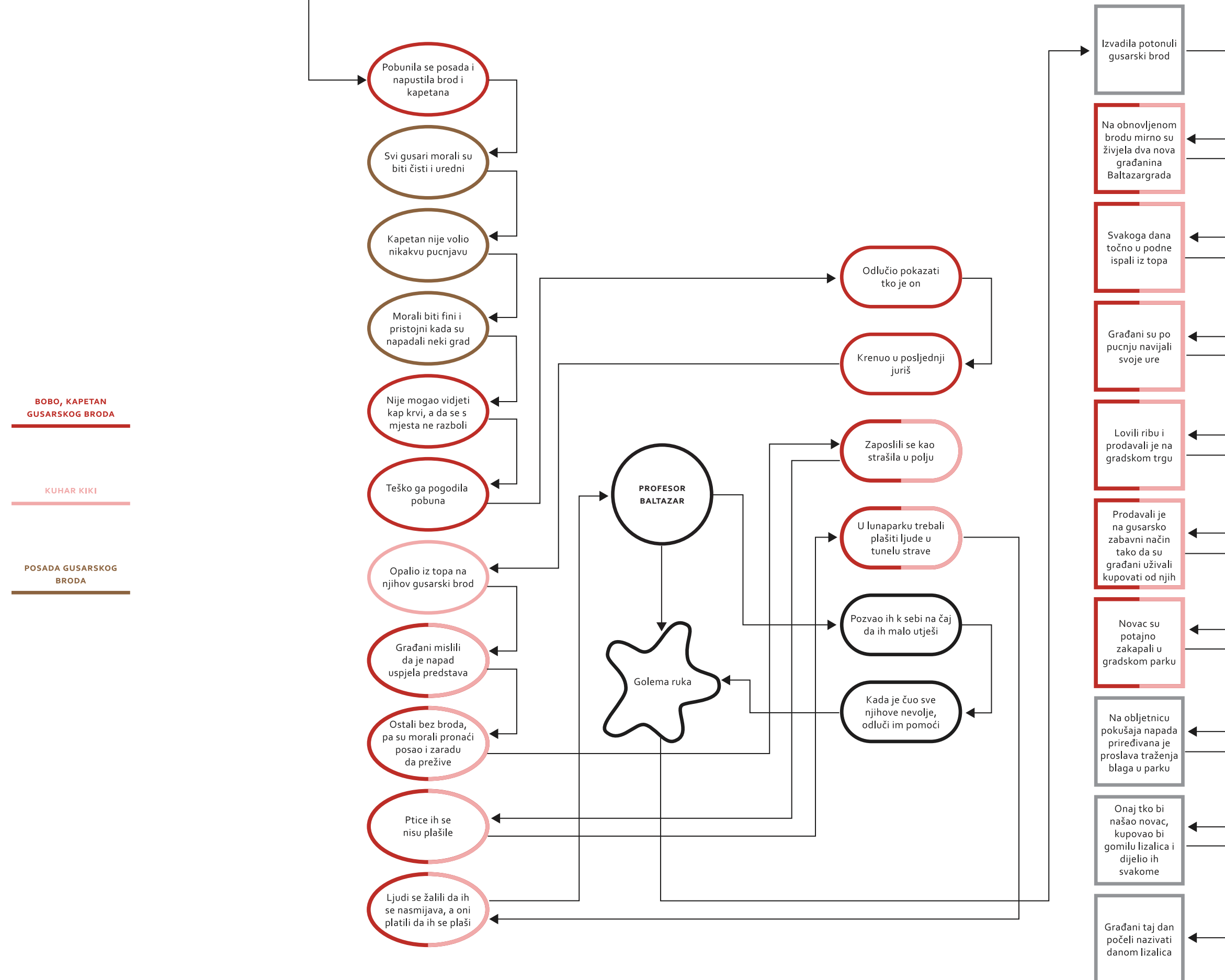

04 Lavlje nevolje

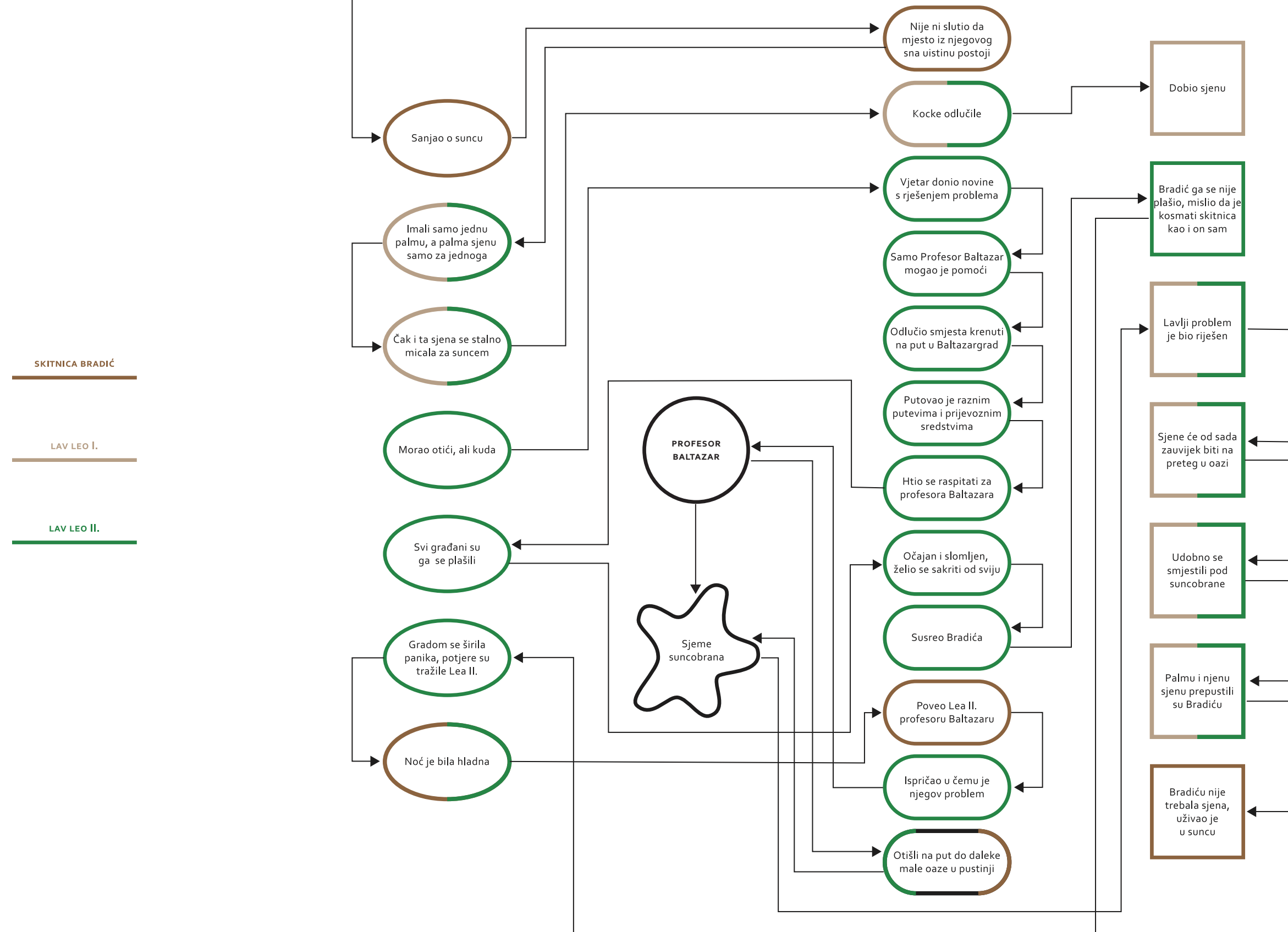

05 Maxol

VRTLAR PINKI

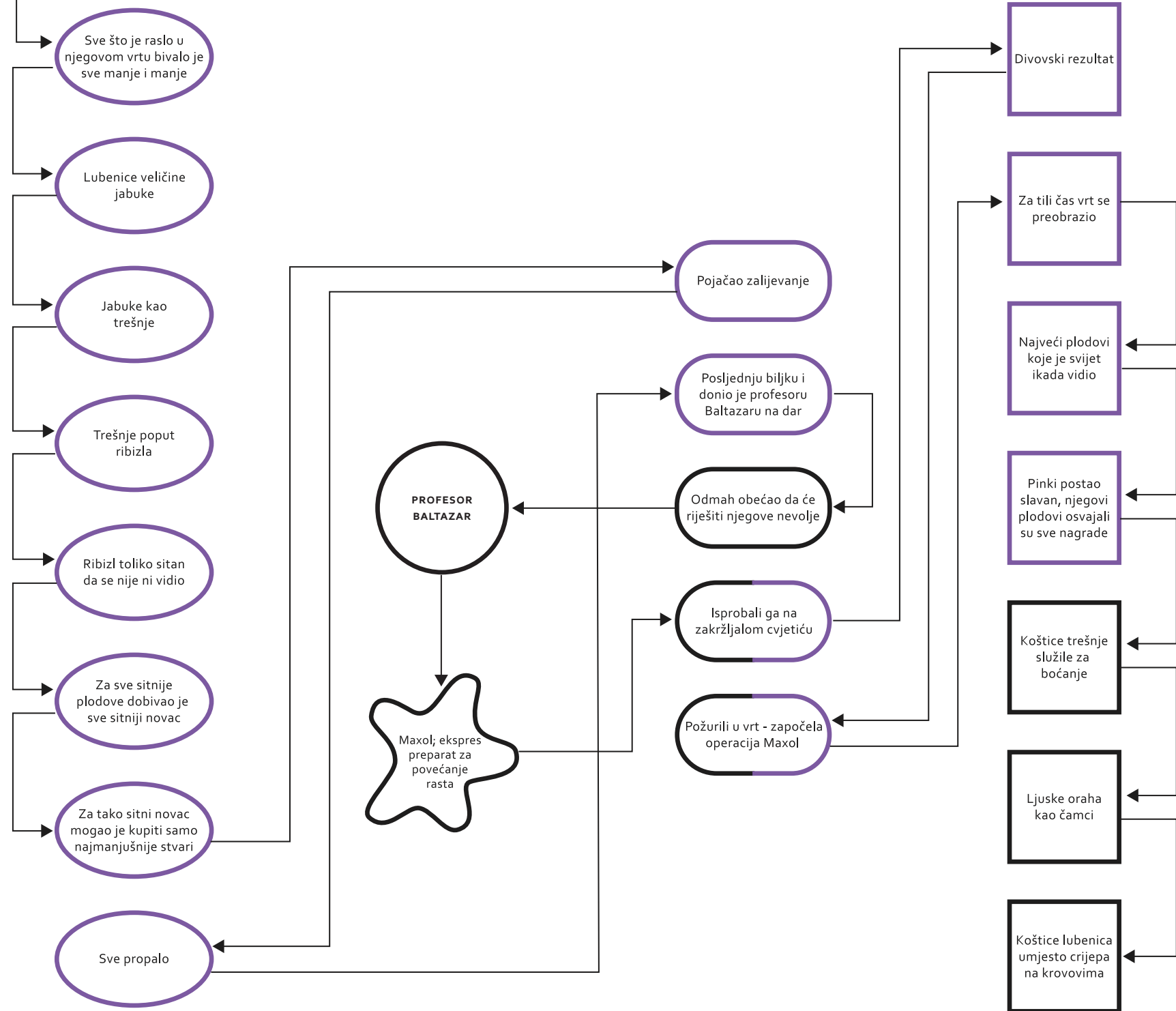

o6 Neman Fu–Fu

**PENZIONIRANI
PRIRODOSLOVAC RUDI**

NEMAN FU–FU

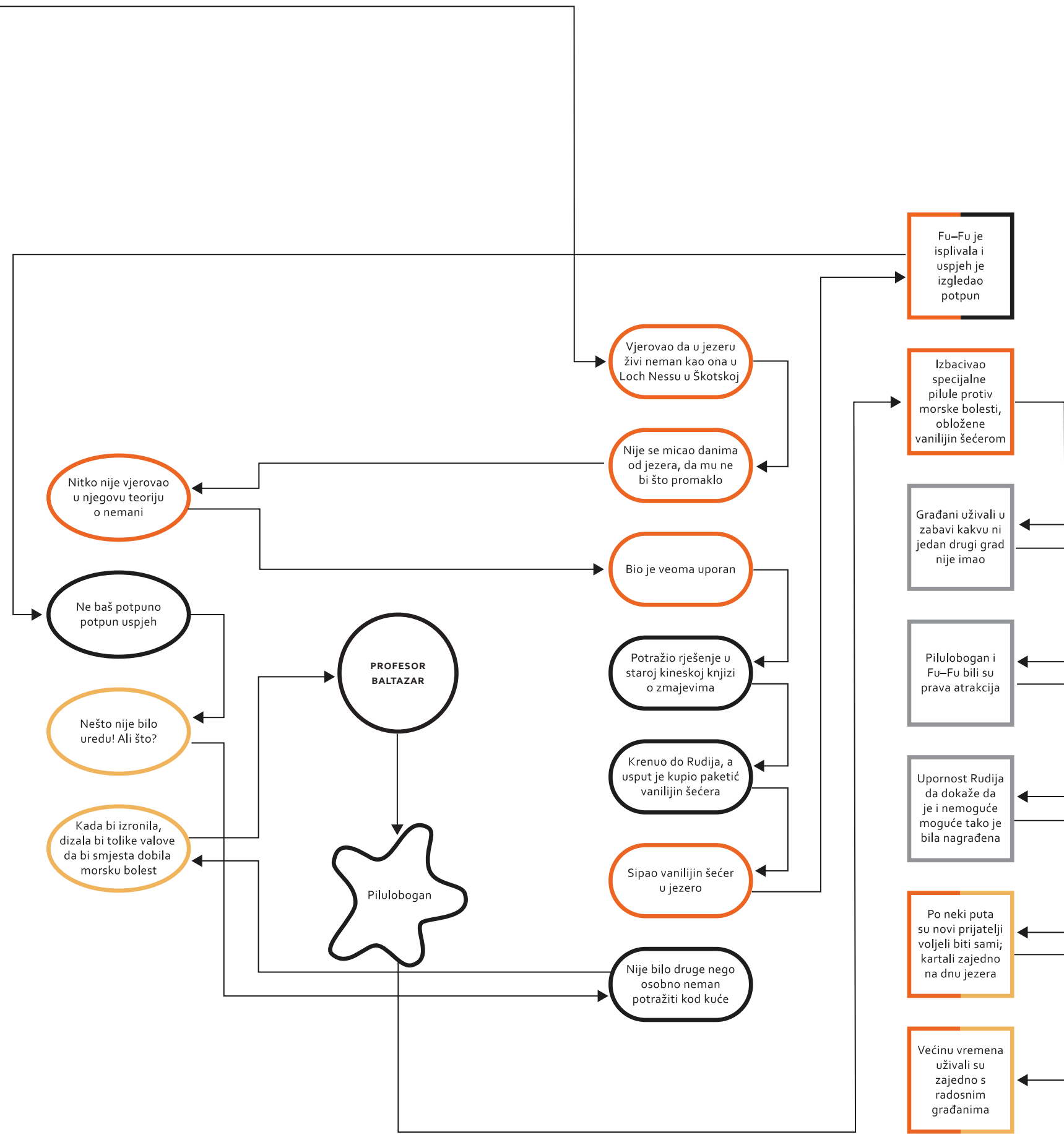

07 Oblačno sa svadavinama

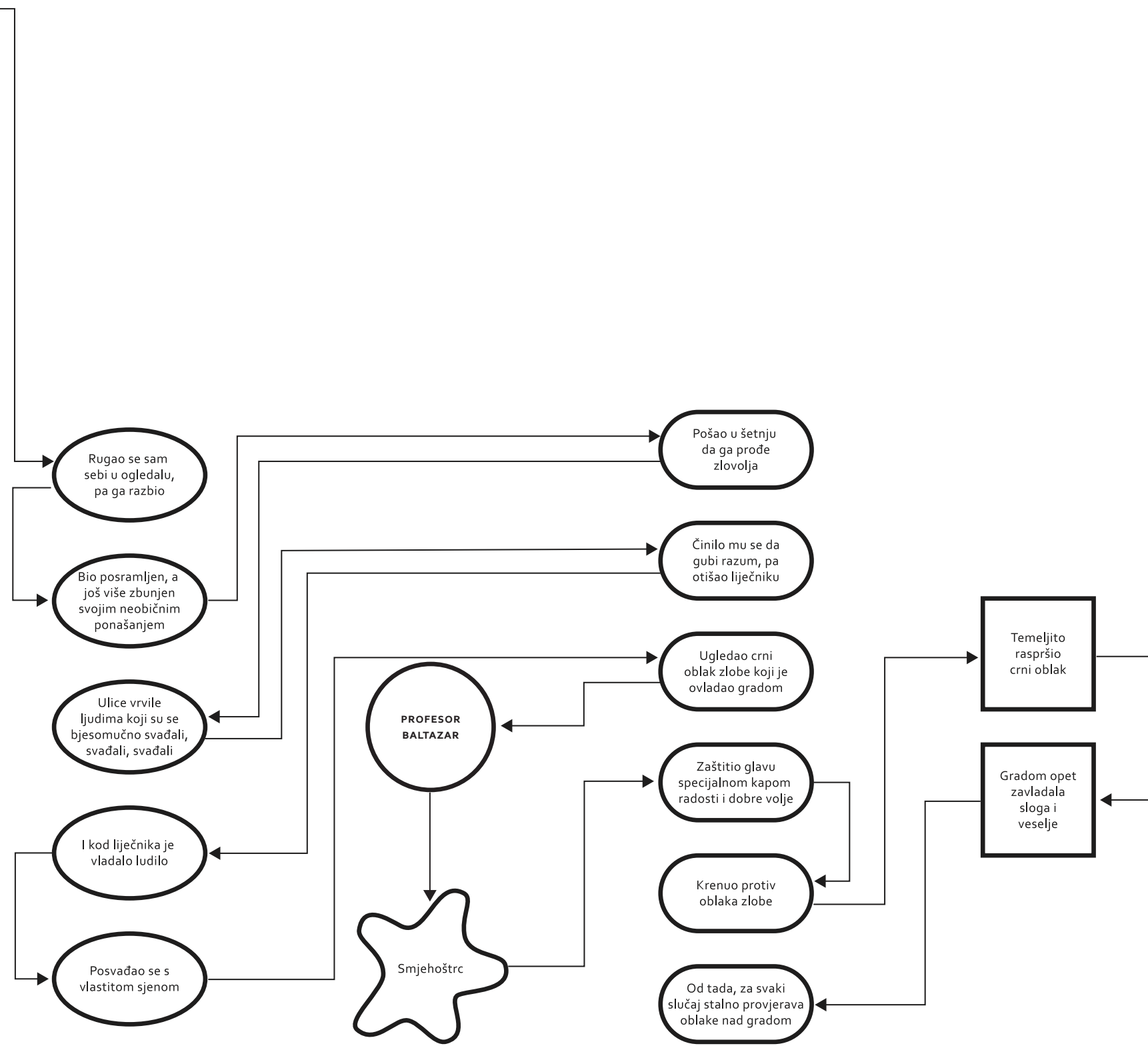

o8 Pepino Cicerone

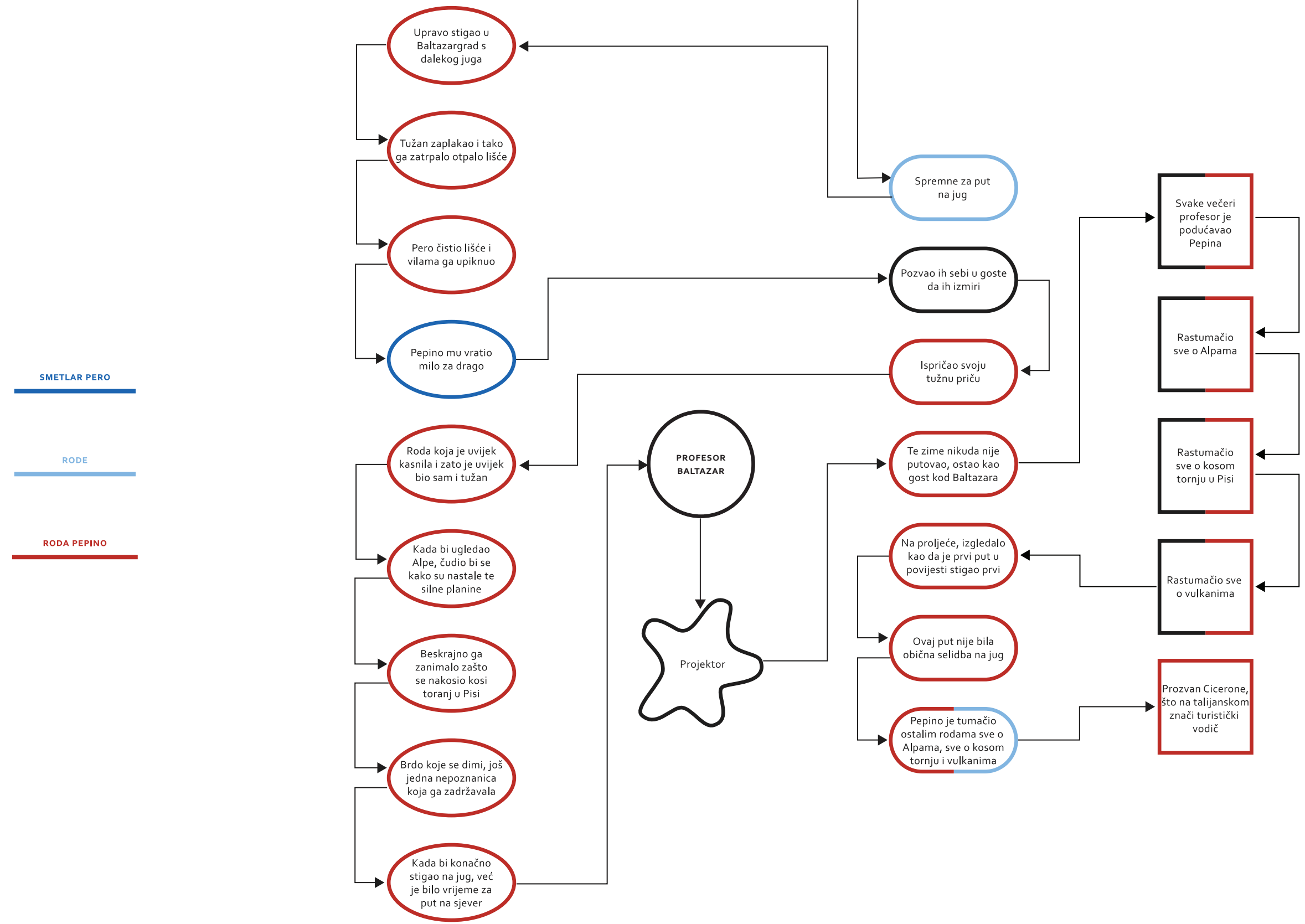

09 Pingvin Čarli

- PINGVIN ČARLI
- GRAĐANI BALTAZARGRADA
- PINGVINKA ŠARLOTA

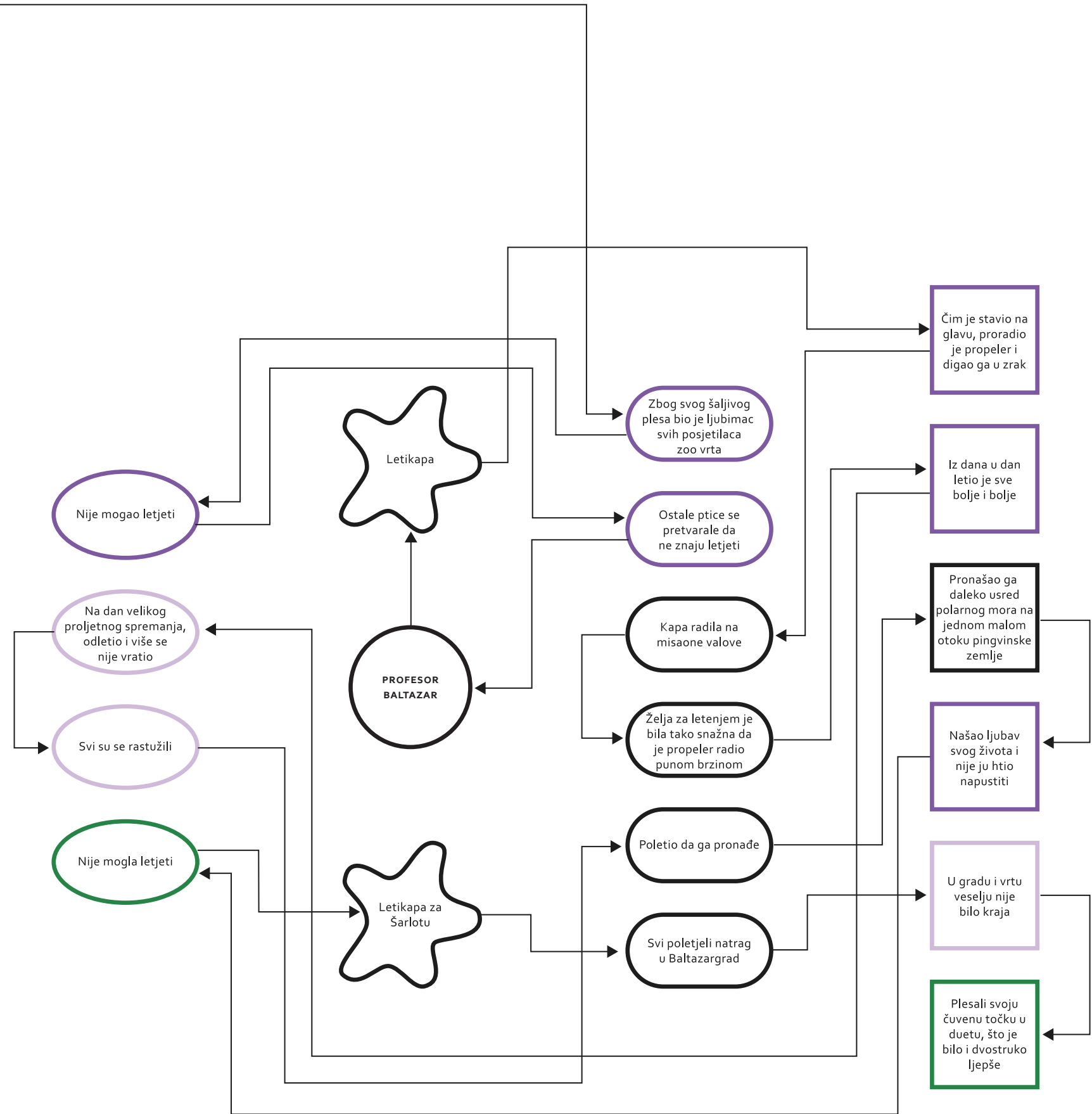

10 Stonožica Božica

- KLOŠAR ALFI
- POŠTAR PERO
- POMETAČ ALBERT
- VATROGASAC FLORIJAN
- SLASTIČAR SEBASTIJAN I NJEGOVA ŽENA
- POLICAJAC MIRKO
- POSTOLAR GAŠPAR
- STONOGA
- DOMAR PERO

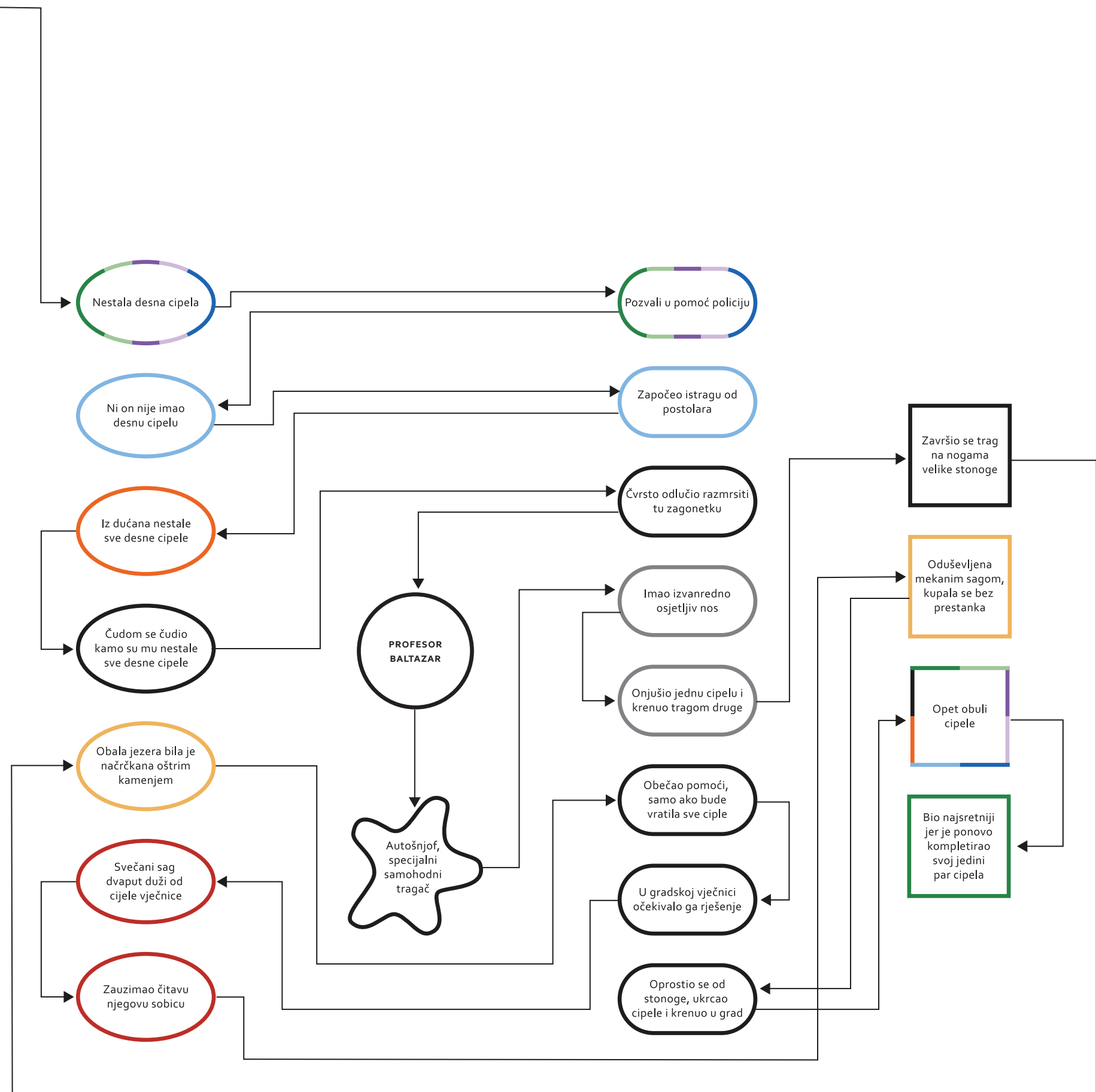

11 Svirka za Mirka

MIRKO, NAJPOPULARNIJI
ČUVAR REDA U
BALTAZARGRADU

FERDINAND, NAJBOLJI
MIRKOV PRIJATELJ

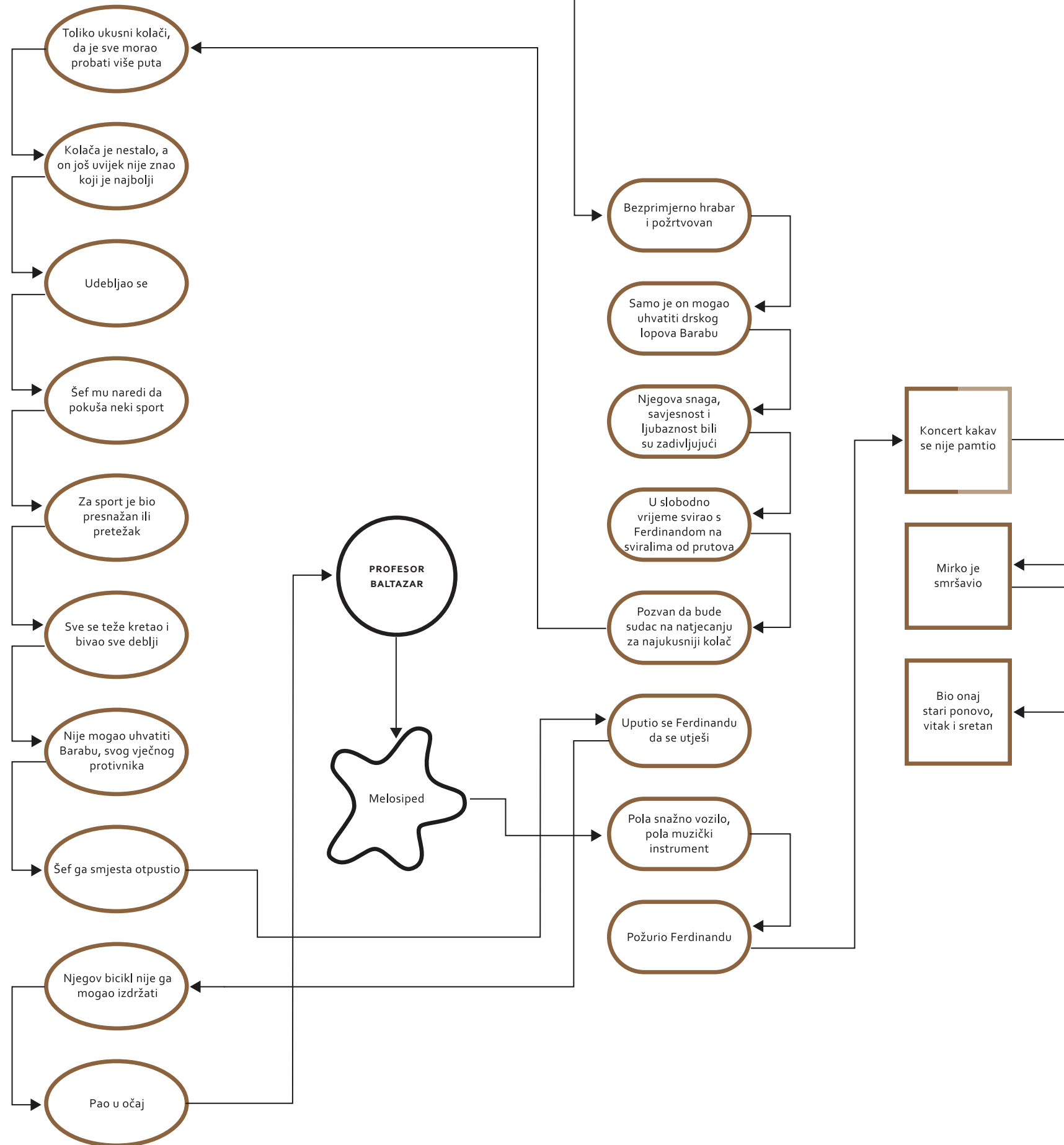

12 Vatrogasna priča

- POLIJGA I ZALIJGA, VATROGASCI**
- GRADONAČELNIK**
- LOVAC LUKA**

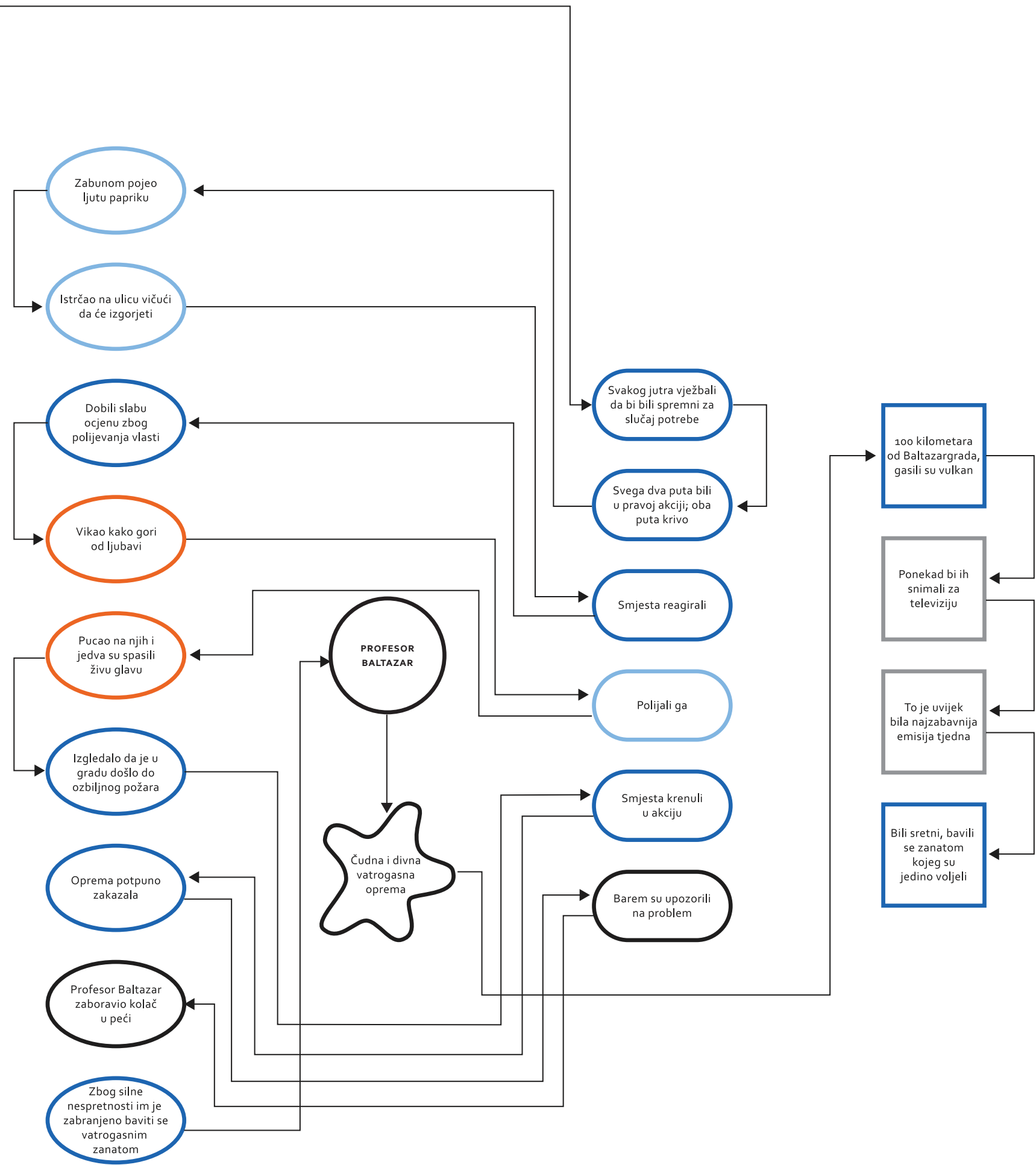

13 Veseli most

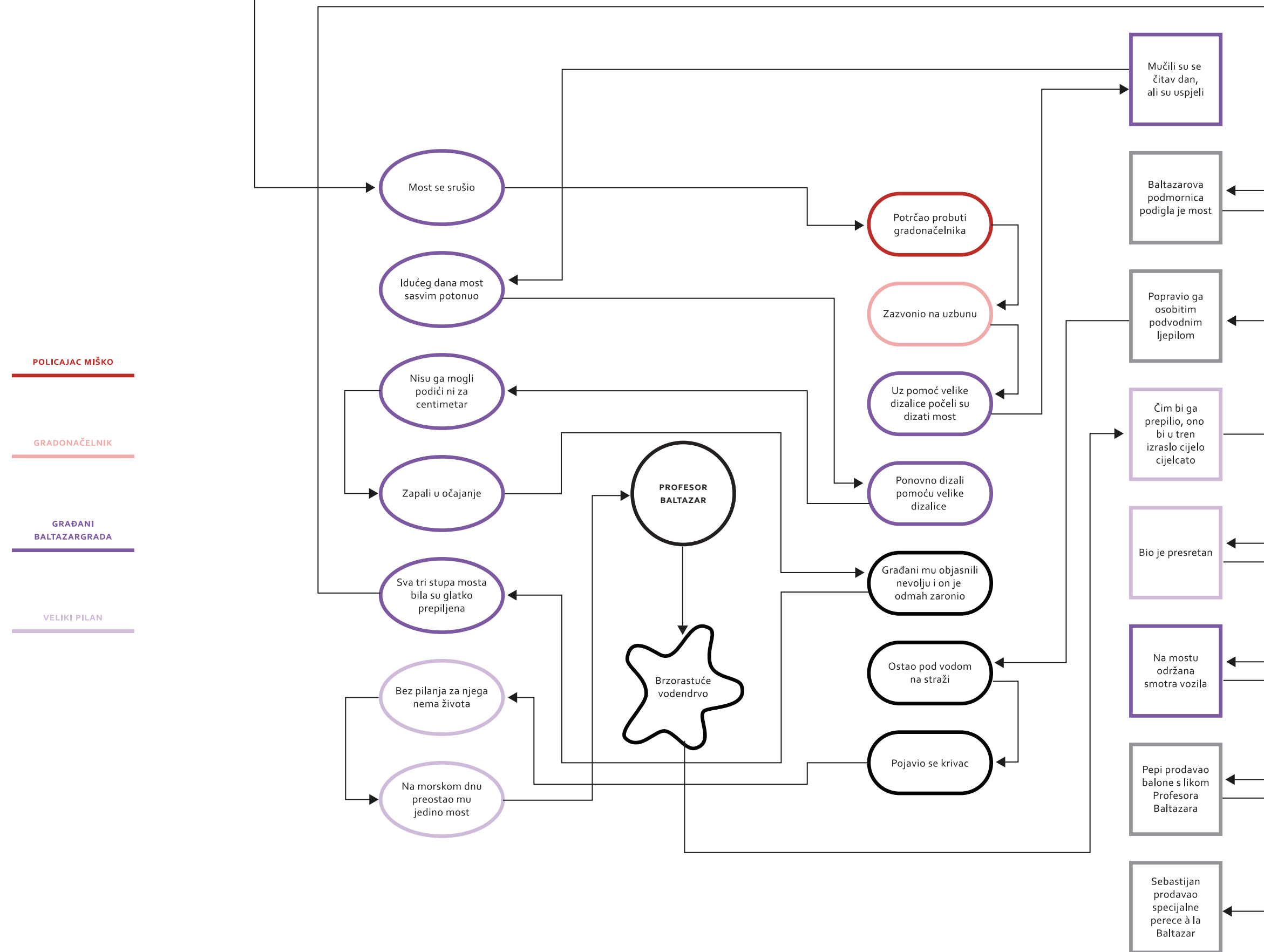

01 Baltazarova ljubav

VIOLETA

FRANC

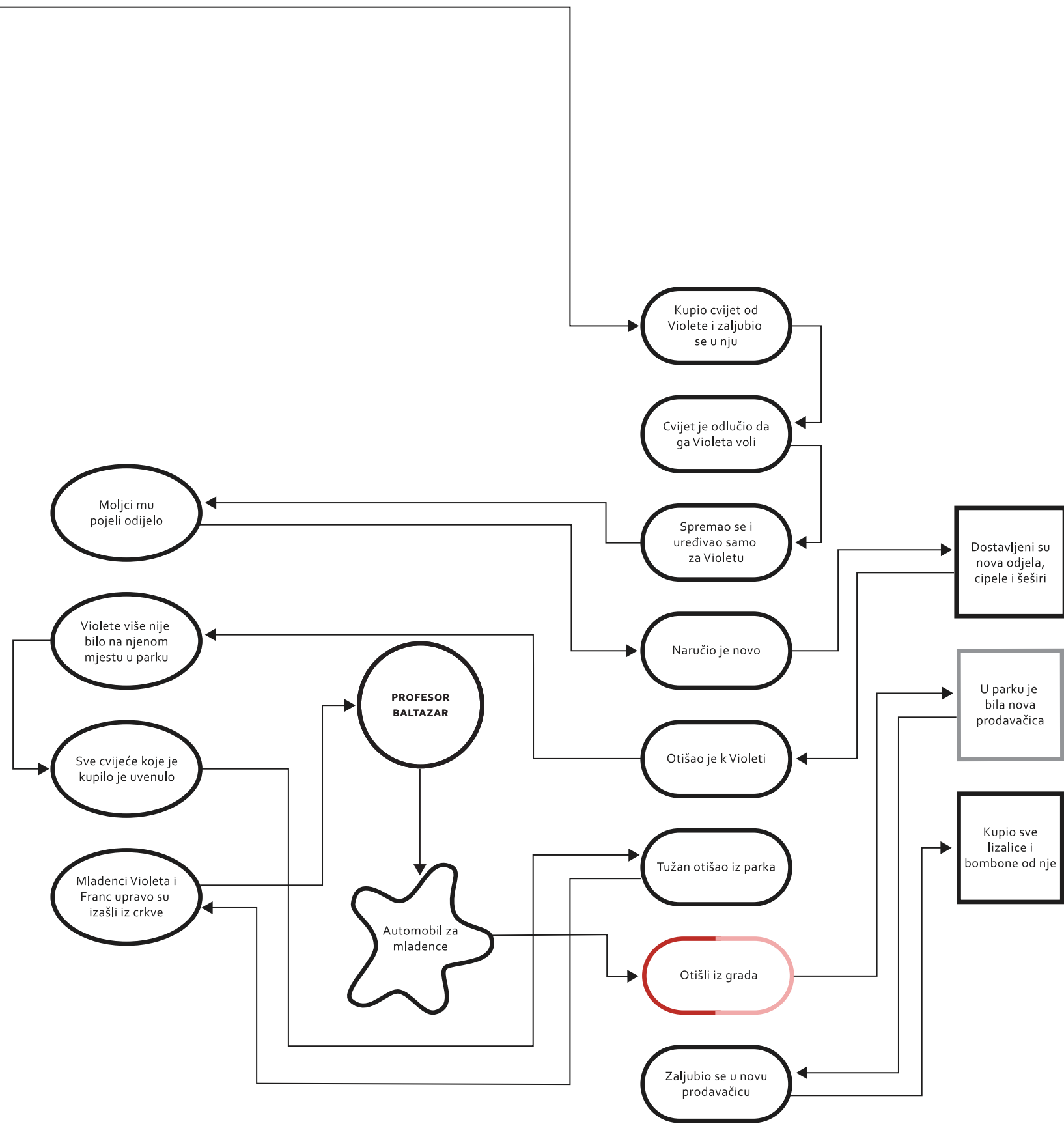

02 Baltazarov sat

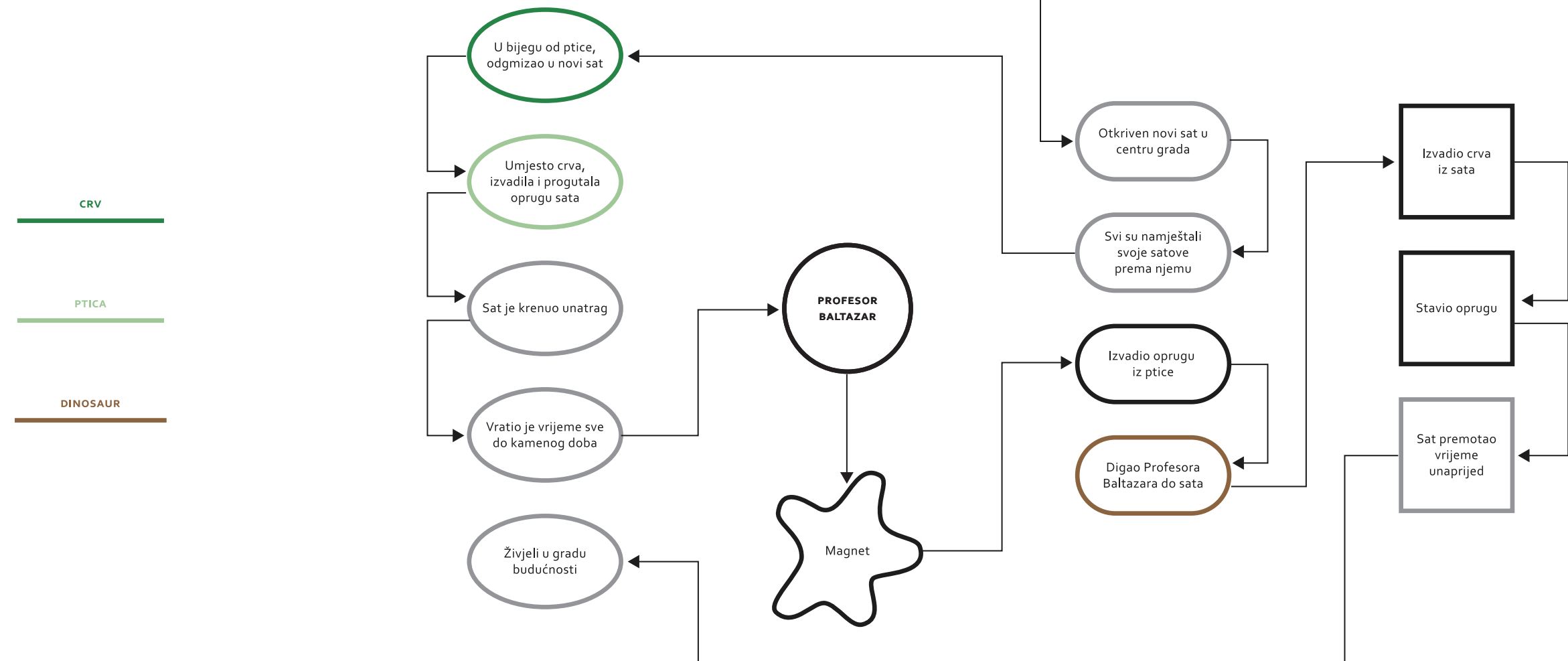

03 Duhovita priča

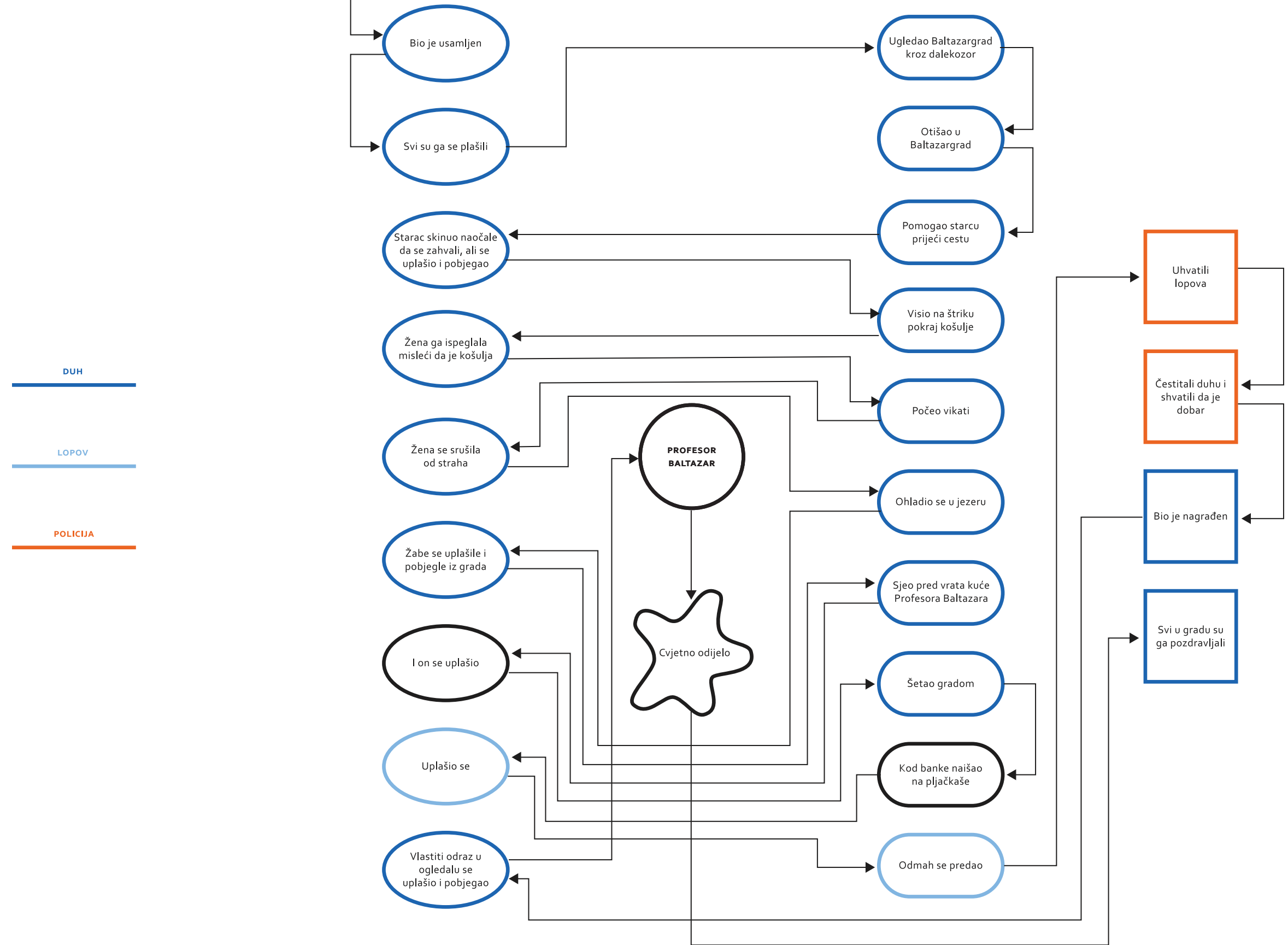

04 Dva cilindra

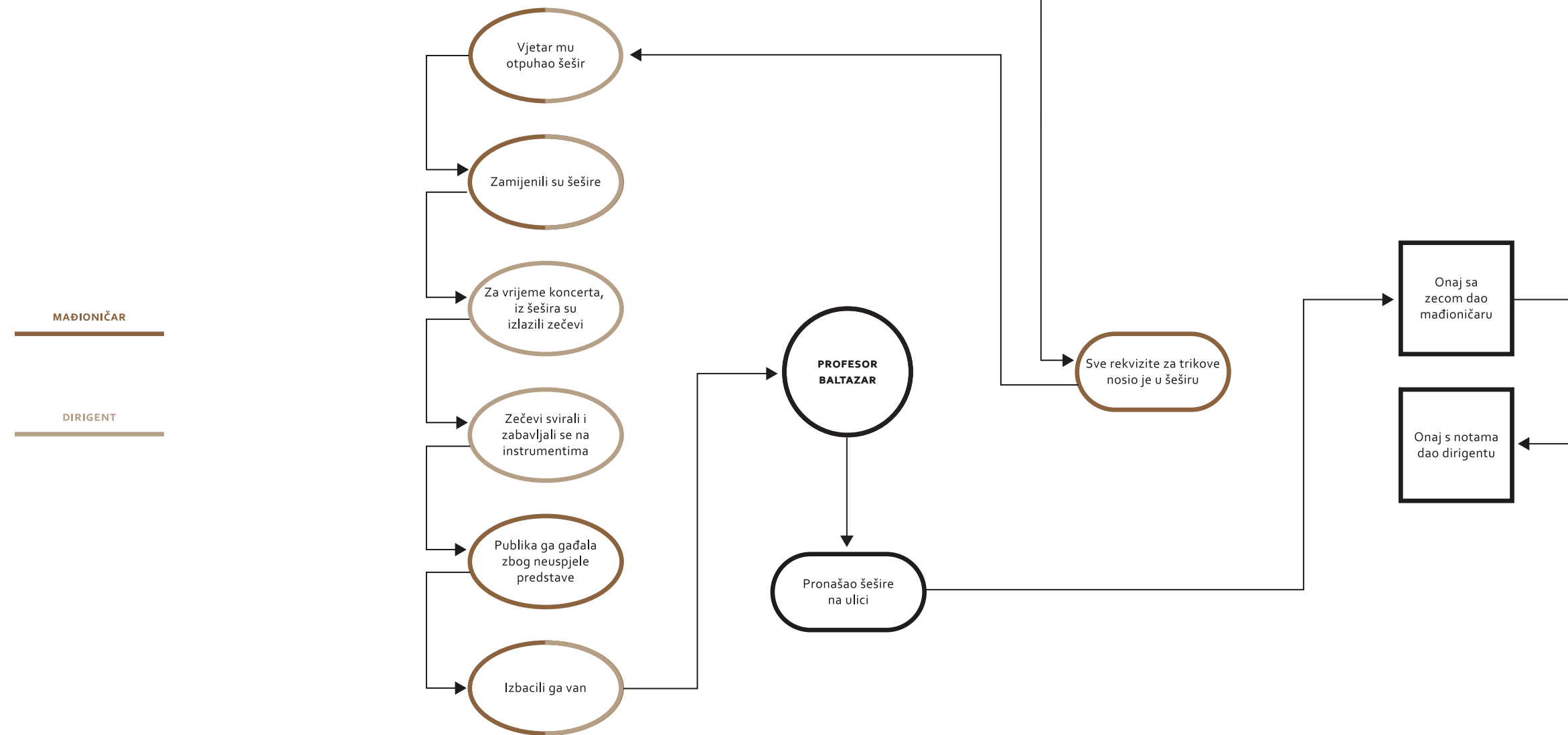

05 Hik

KNOBAR U RESTORANU

GRAĐANI
BALTAZARGRADA

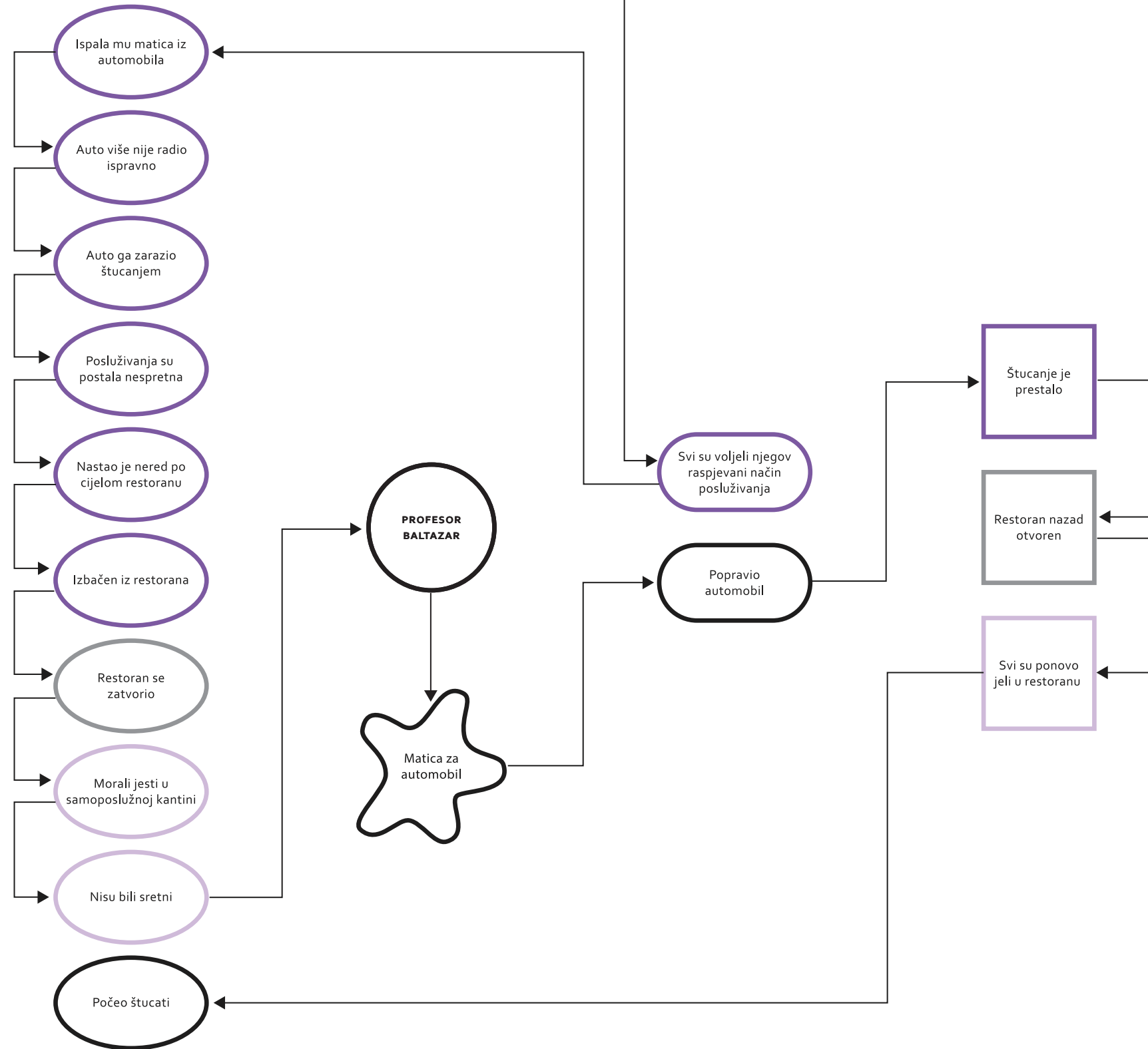

o6 Izgubljeni zec

MADIONIČAR

ZEC

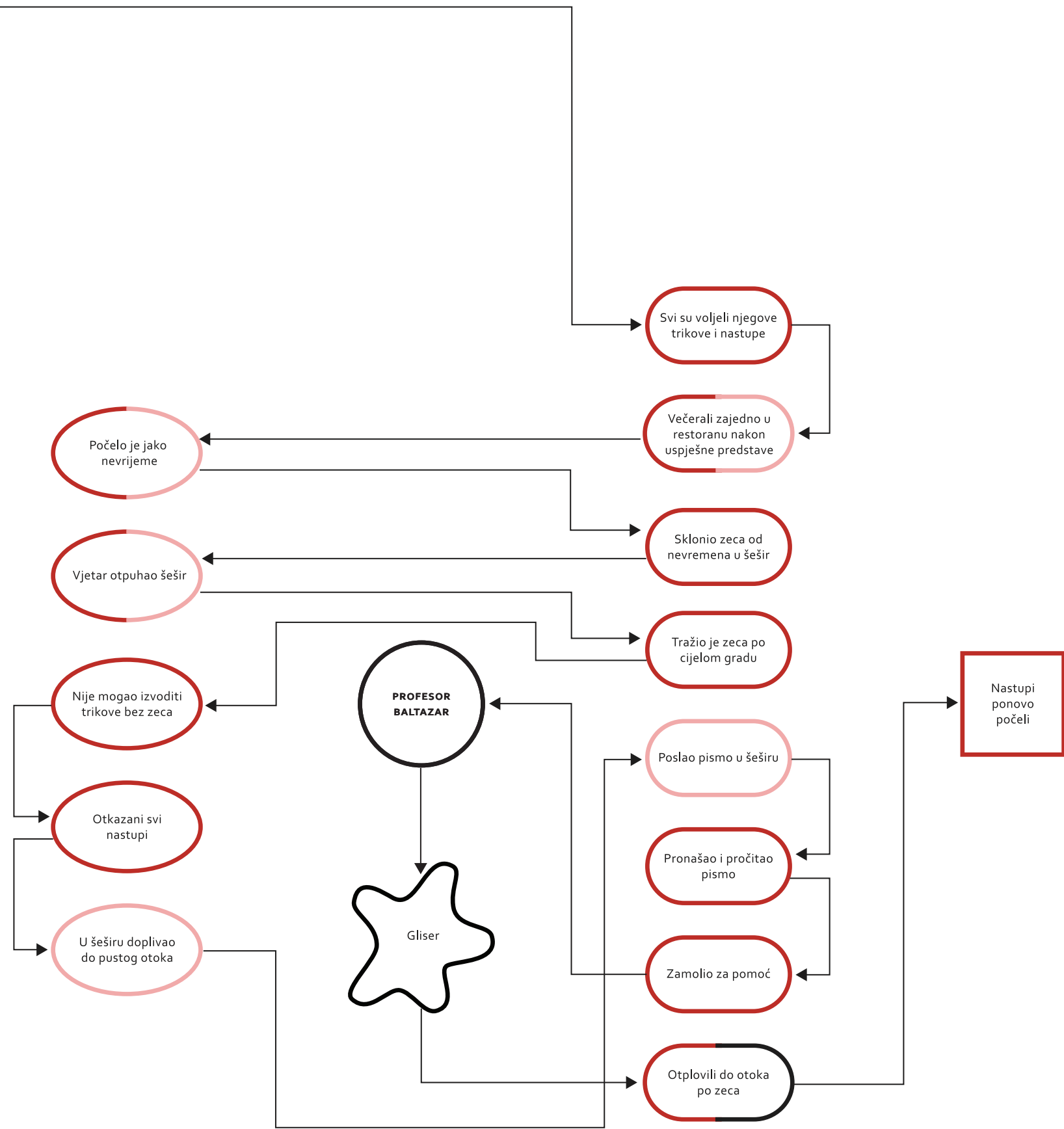

07 Igrati se lovice

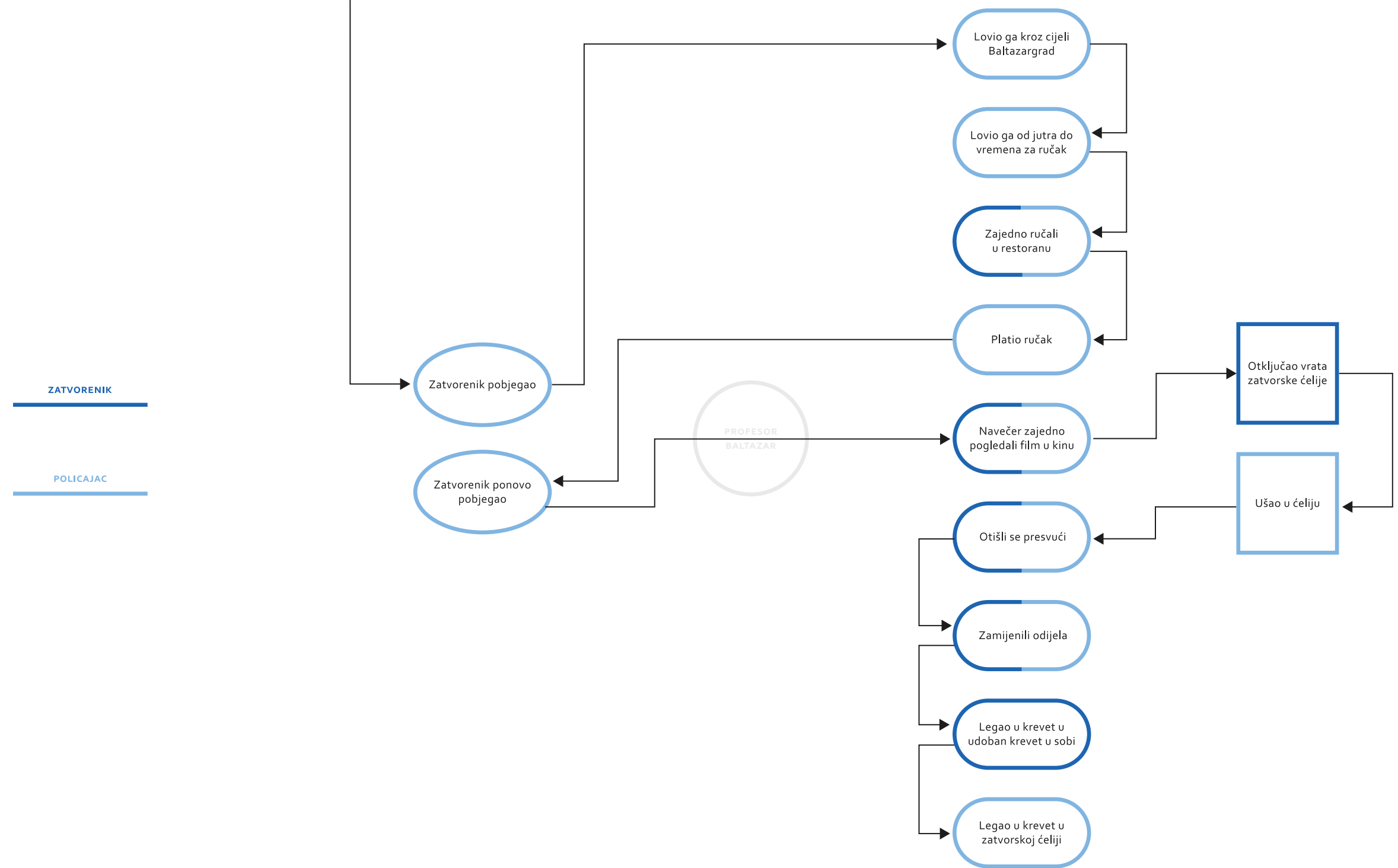

o8 Klaun Danijel

GORNJI KLAUN

DONJI KLAUN

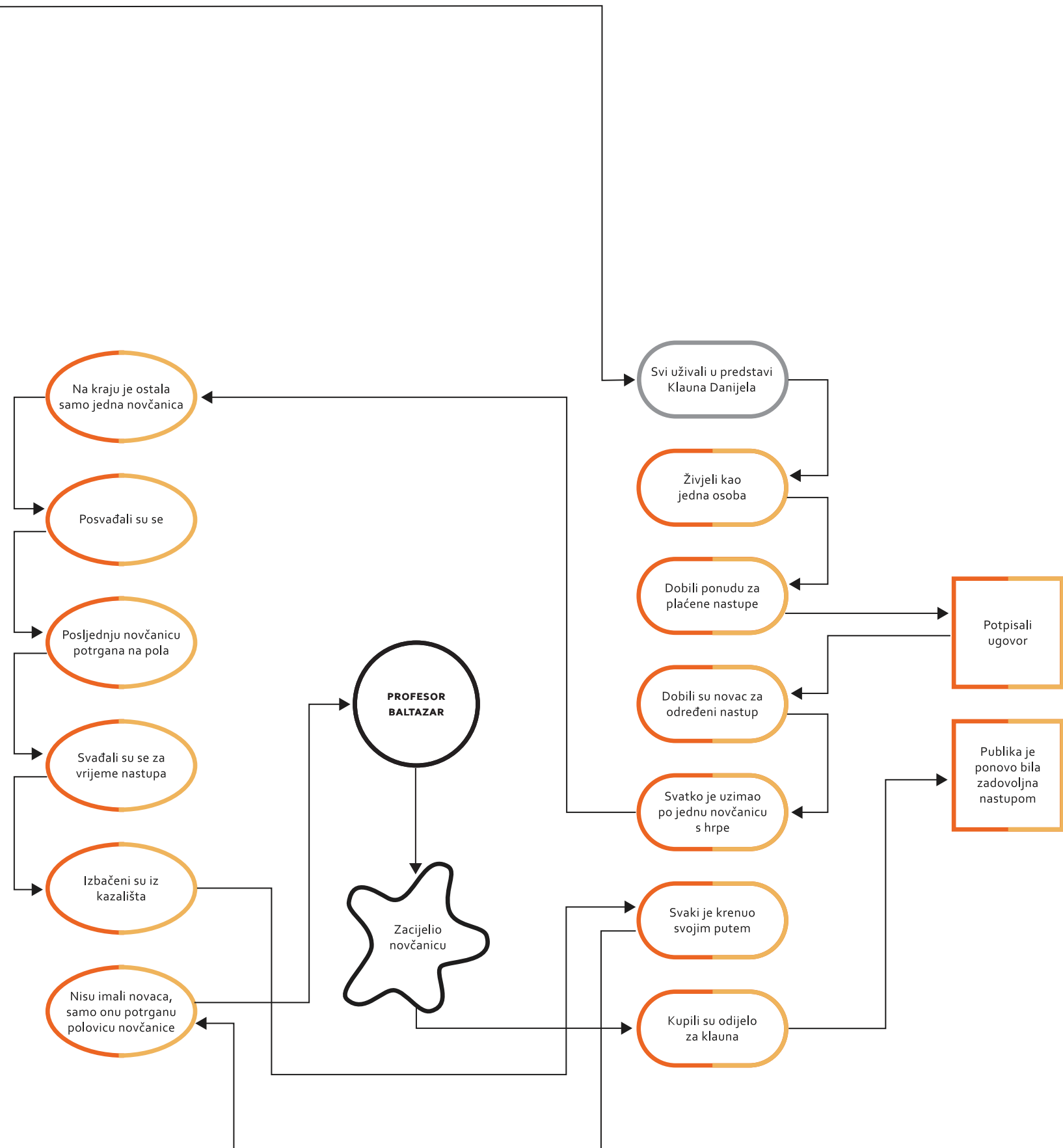

09 Obučar Kroko

- OBUČAR KROKO
- PTICA, KROKOV POMOĆNIK
- PEKAR
- GRAĐANI BALTAZARGRADA

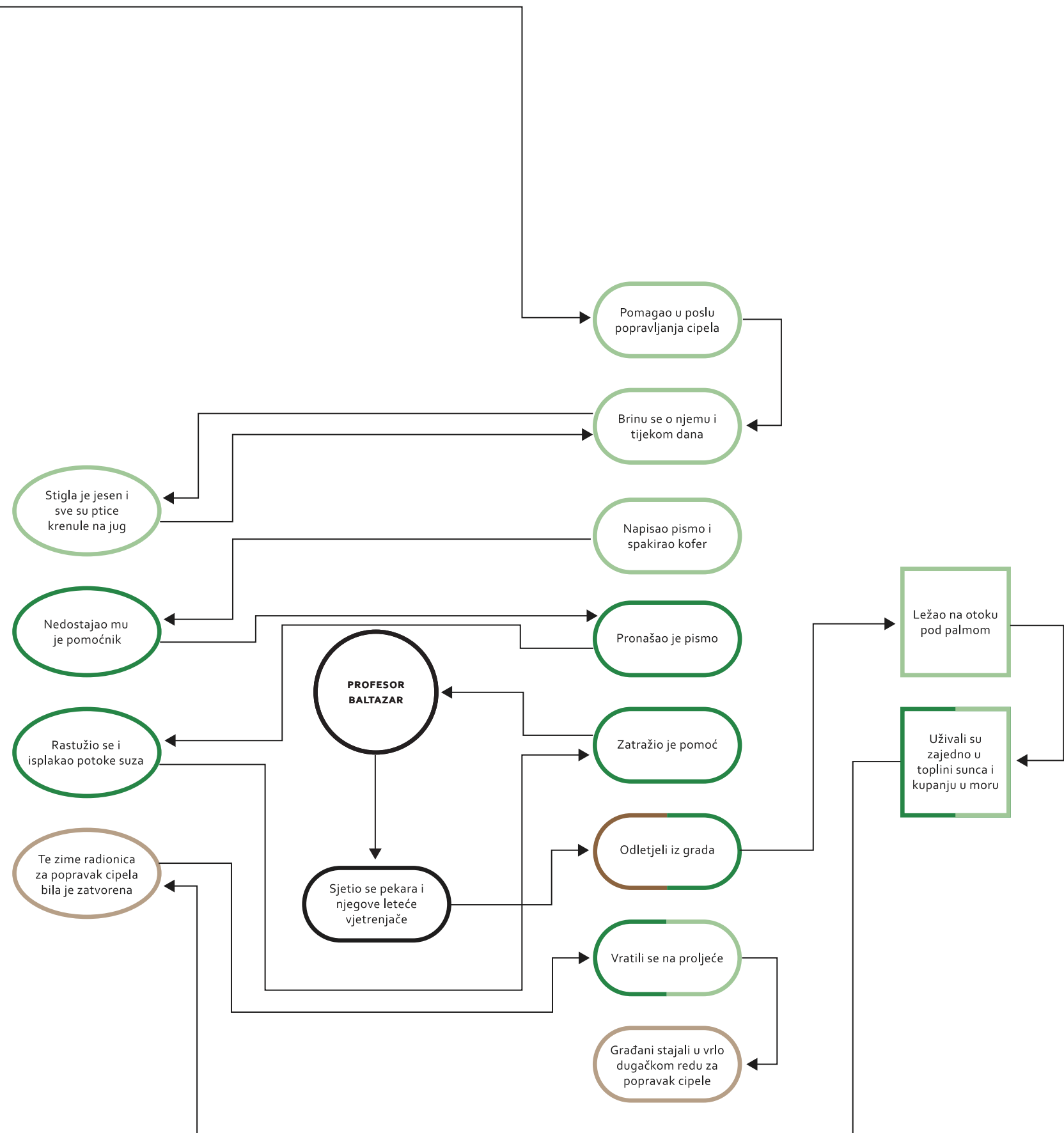

11 Pingvin Alex

- POŠTAR
- PINGVIN ALEX
- GRAĐANI BALTAZARGRADA

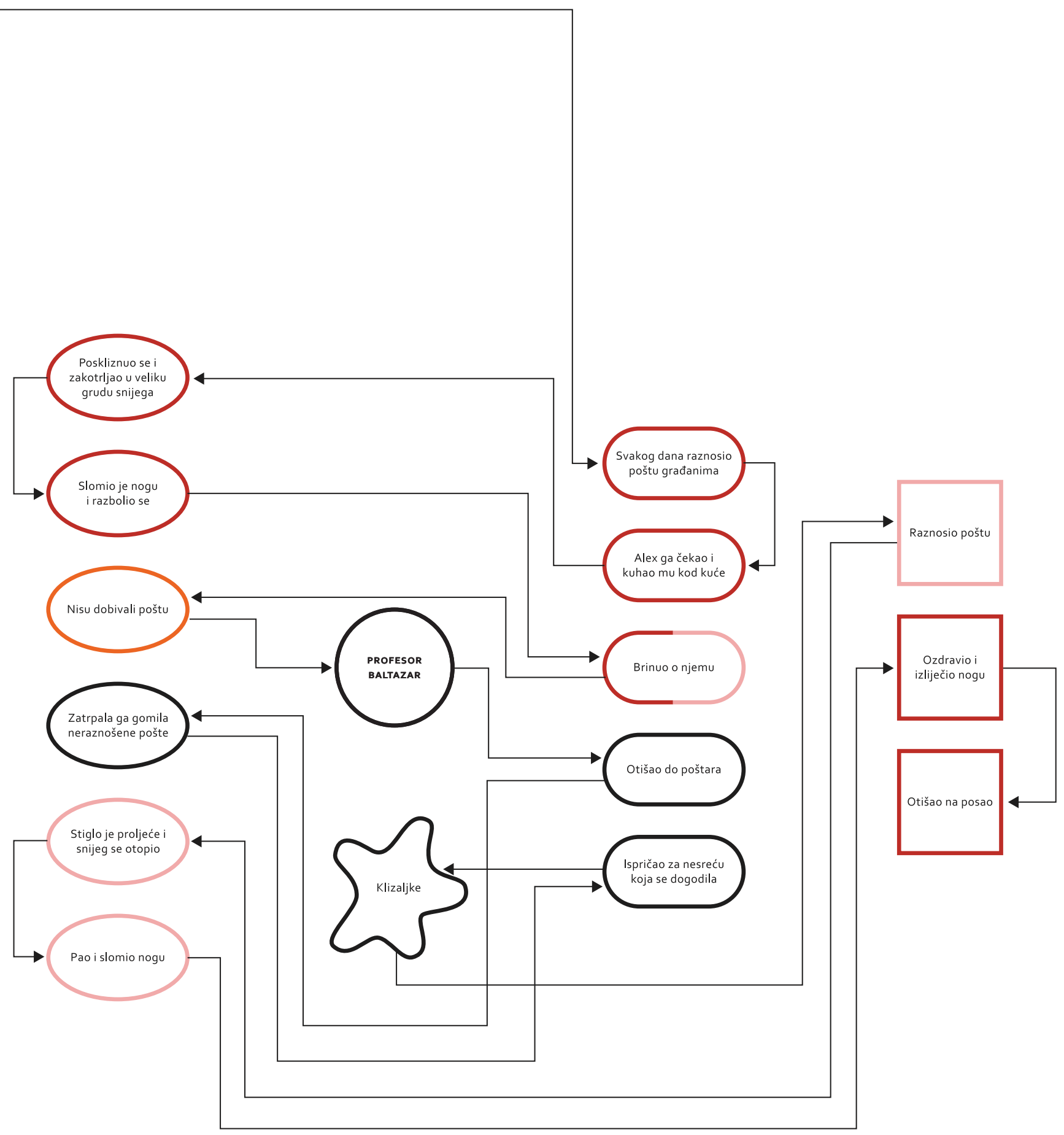

12 Posao je posao

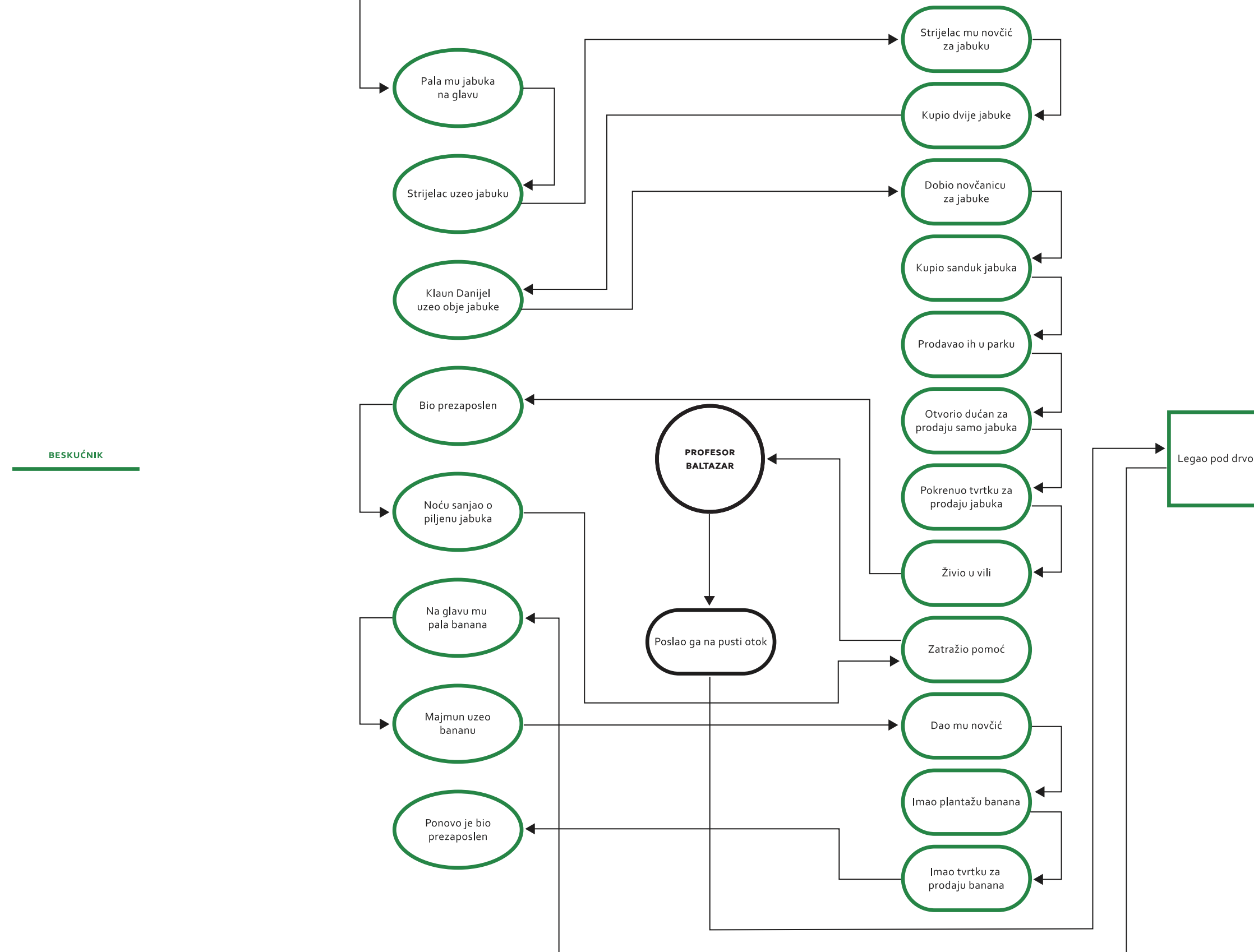

BESKUĆNIK

13 Ptica

PTICA 1
PTICA 2

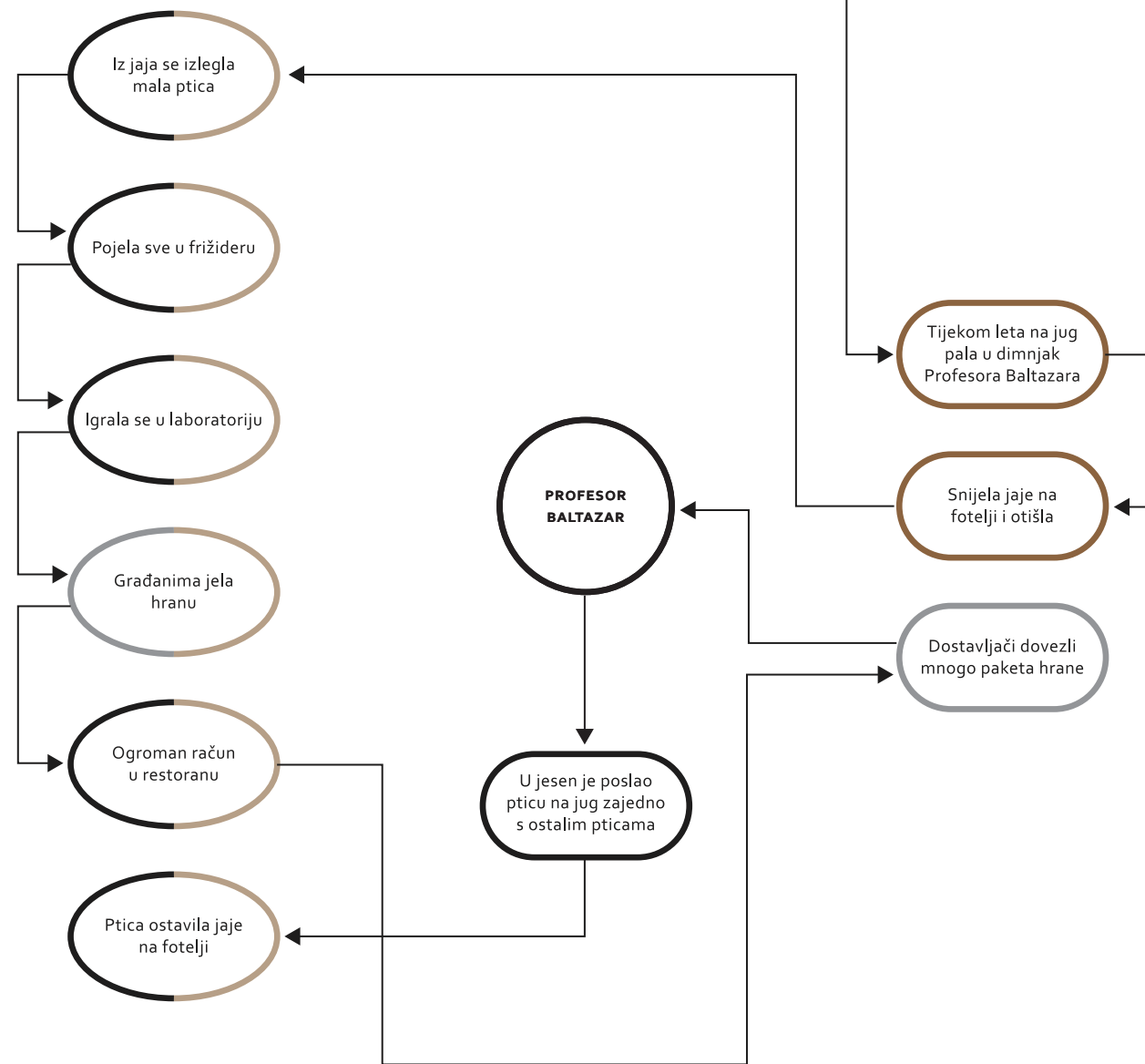

14 Sportski život

MAČAK

ŽENA

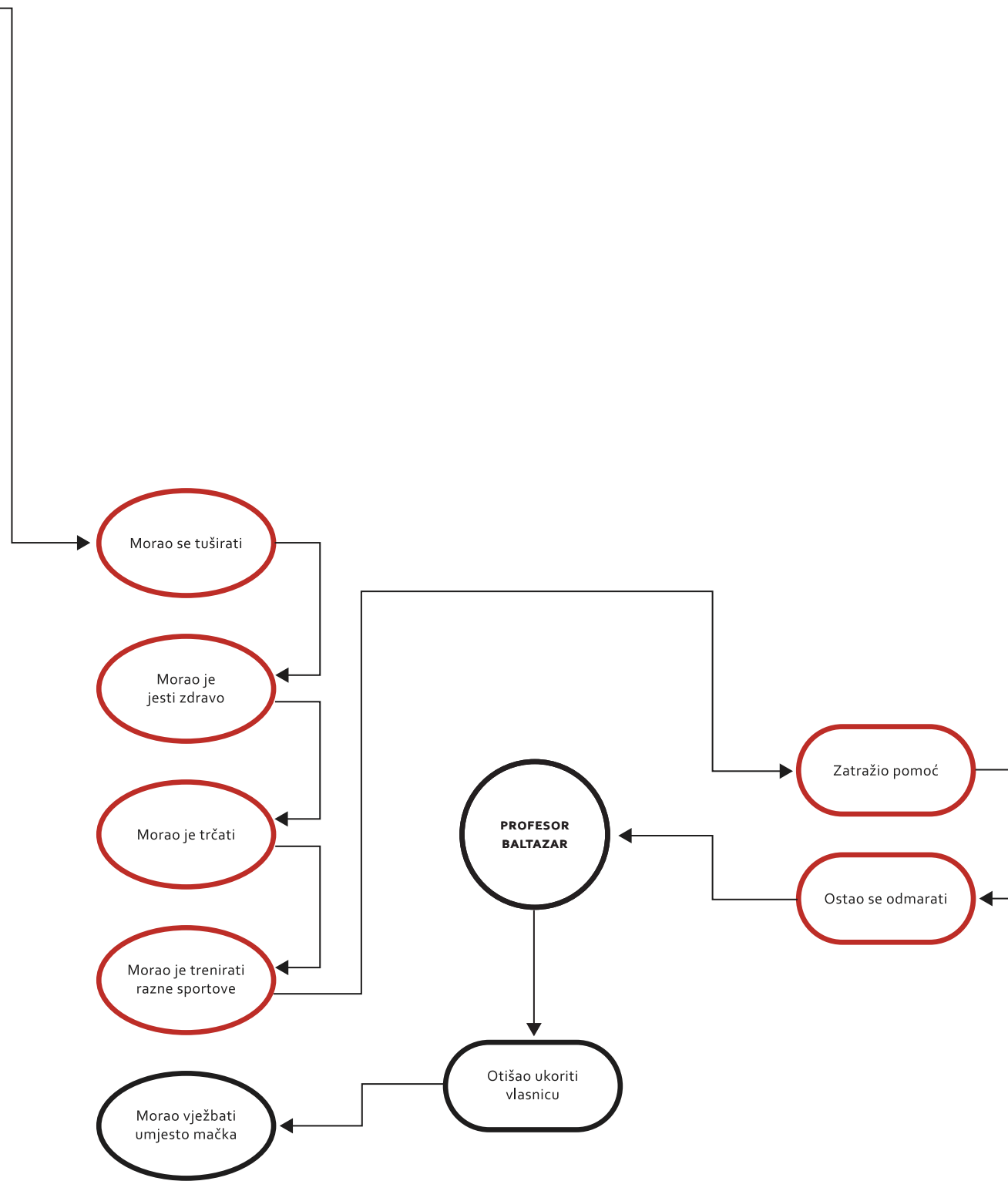

15 Šampion

TRKAĆI KONJ

DRESER KONJA

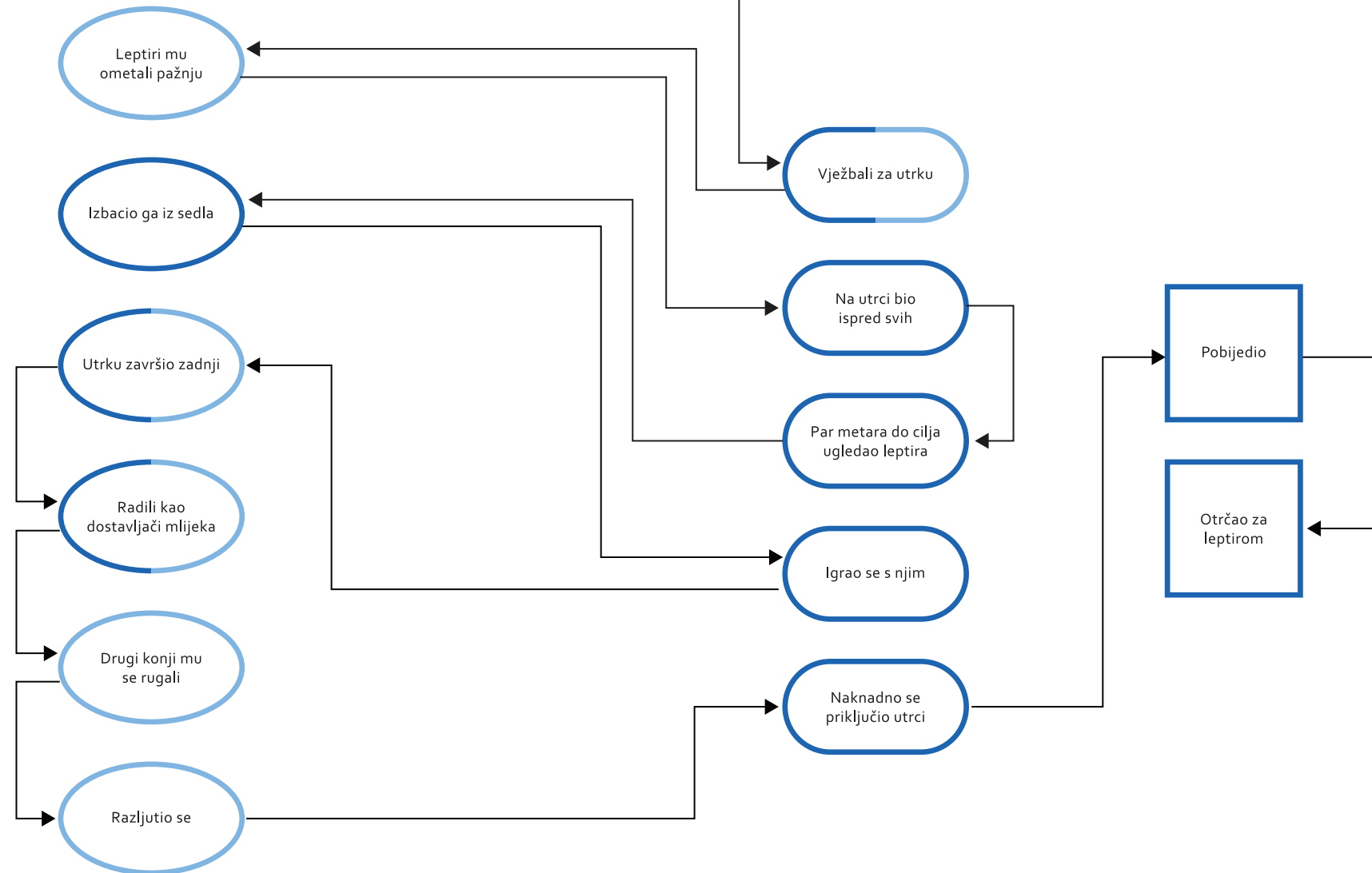

16 Ulični svirači

MEDVJED HARMONIKAŠ

PLESAČ

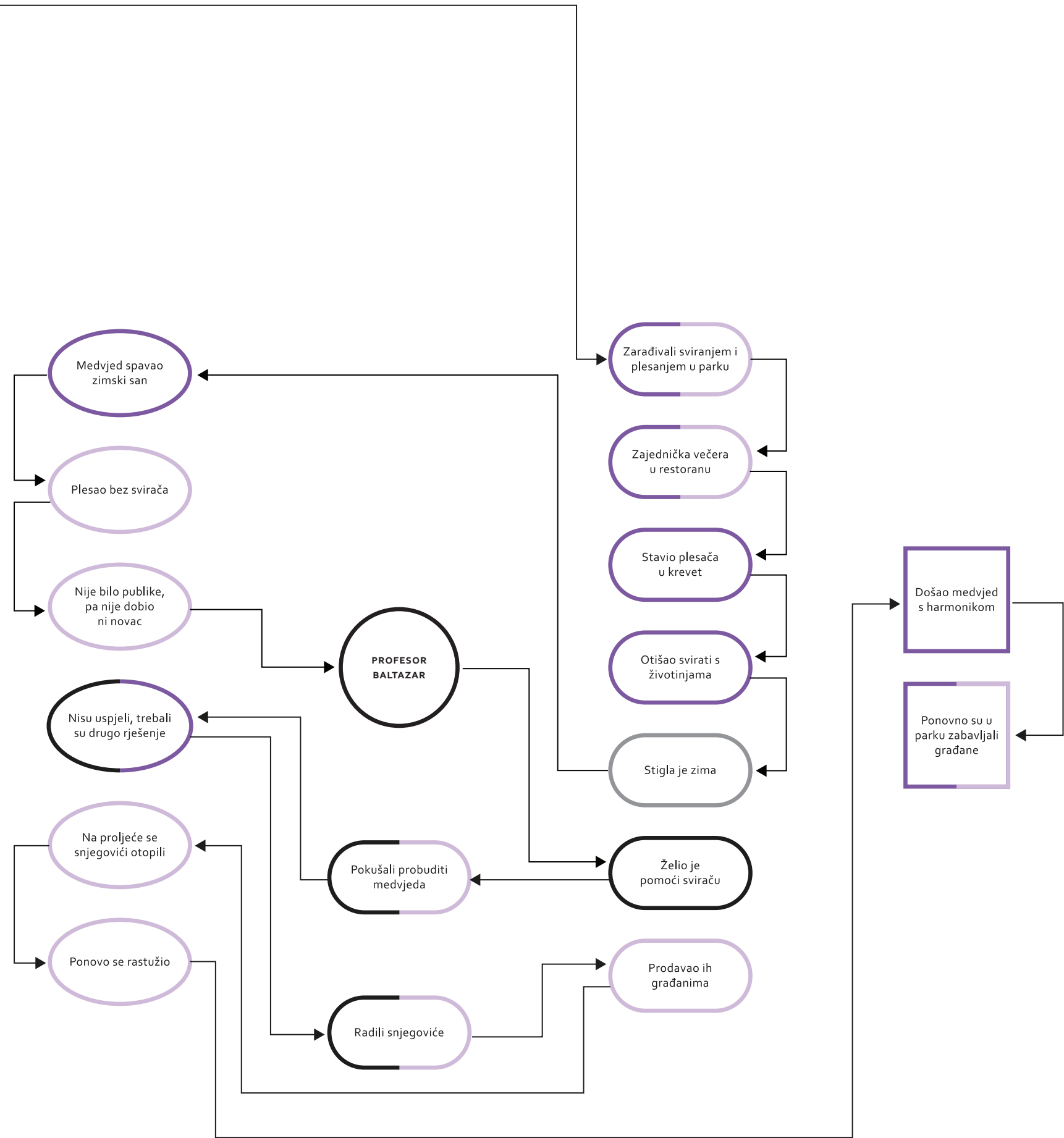

17 Veliko hrkanje

- MEDVJED HARMONIKAŠ
- GRAĐANI BALTAZARGRADA
- MEDVJEDI IZ ŠUME

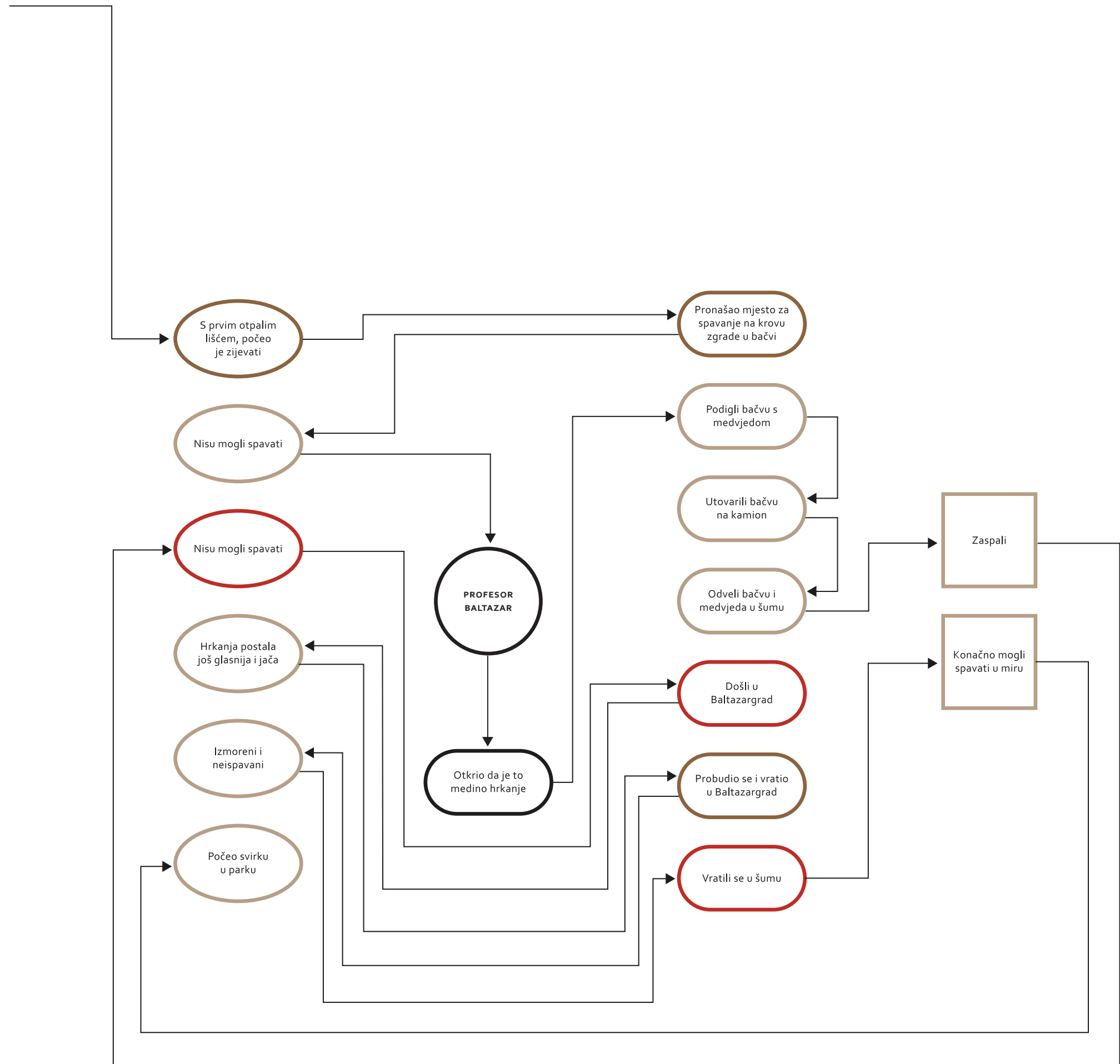

18 Violeta i Franc

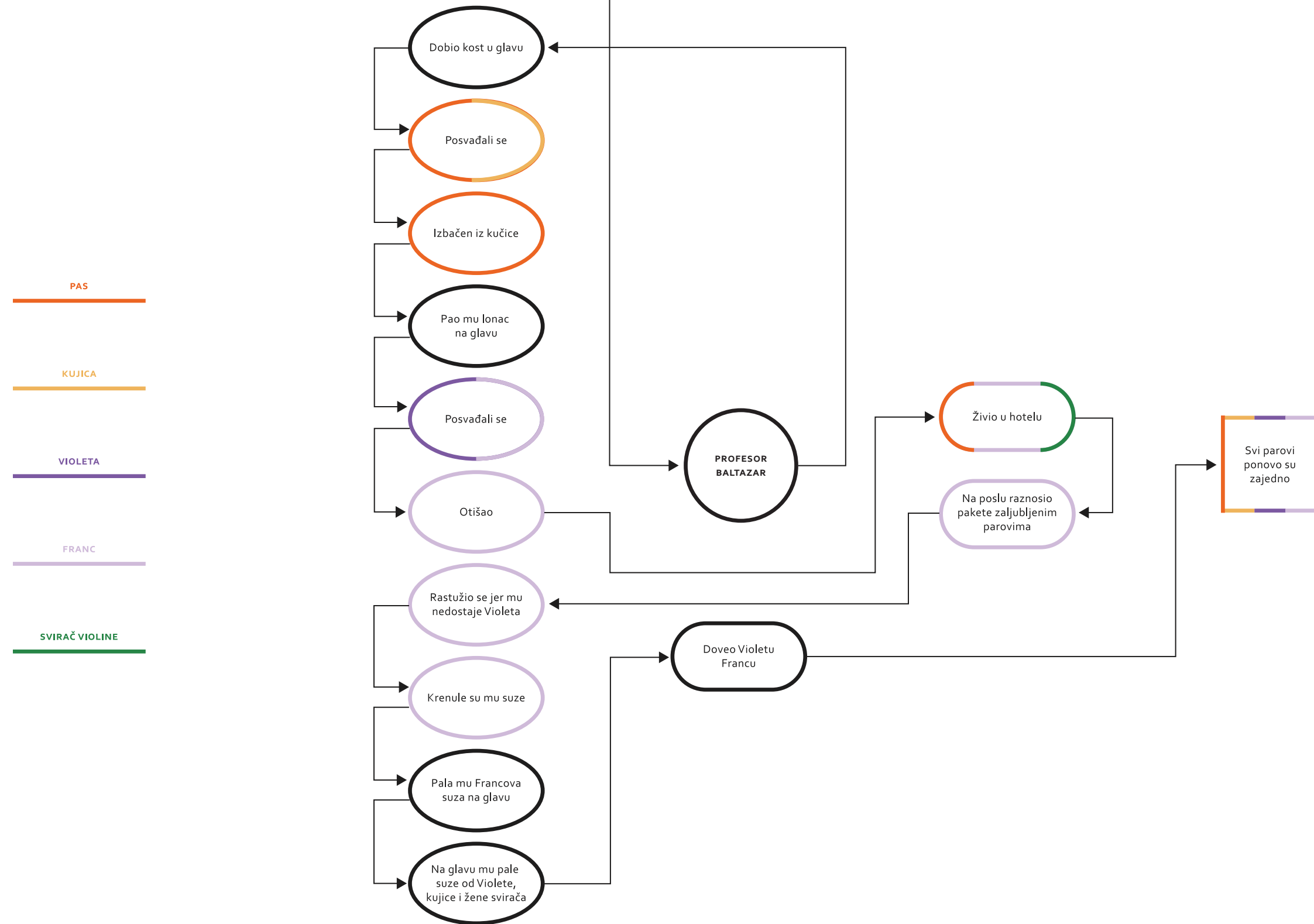

19 Vjetrenjača

- PEKAR
- MIŠ
- PAS

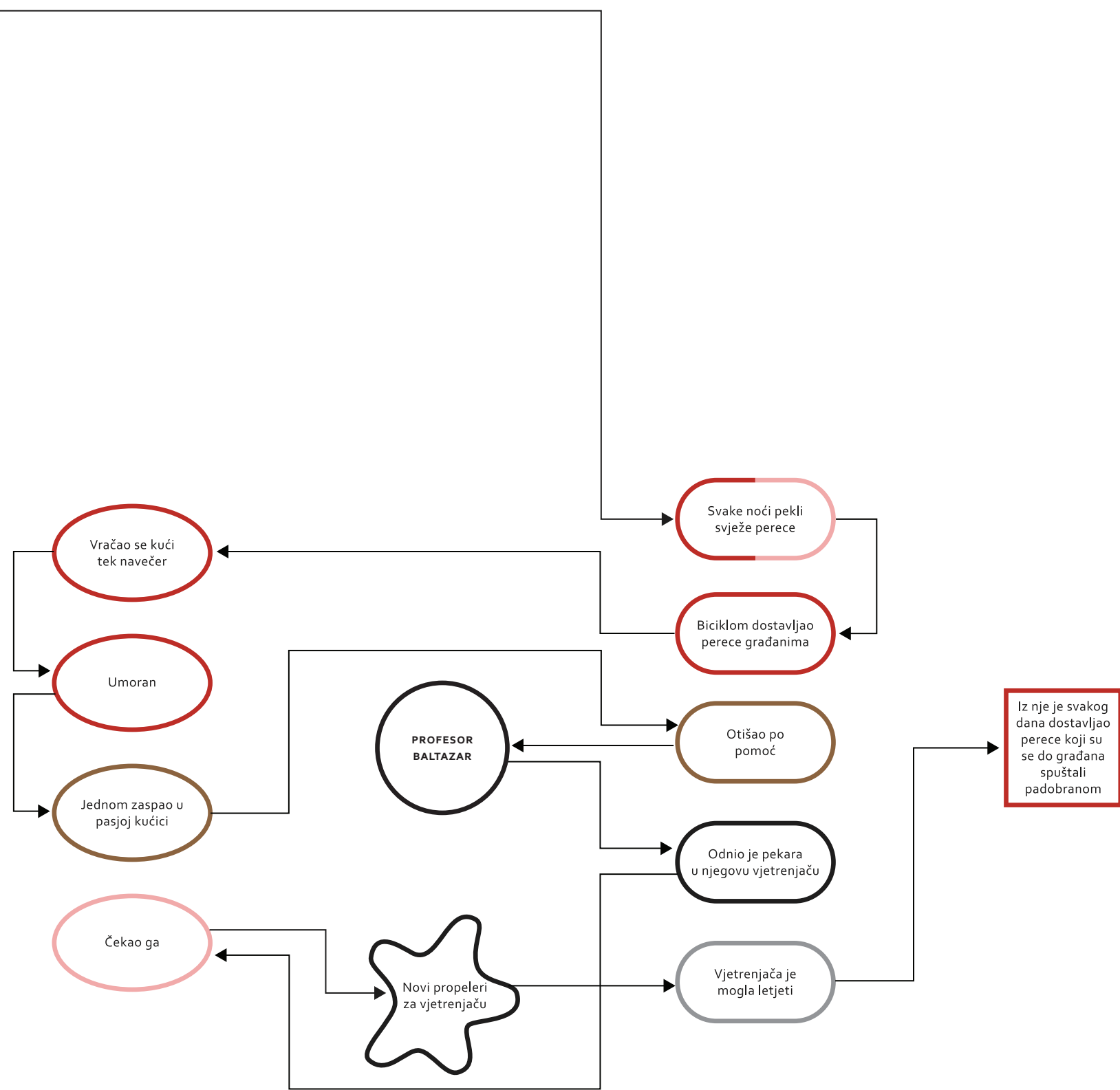

20 Zrak

- GRAĐANI BALTAZARGRADA
- CRNI OBLAK
- PODUZETNIK

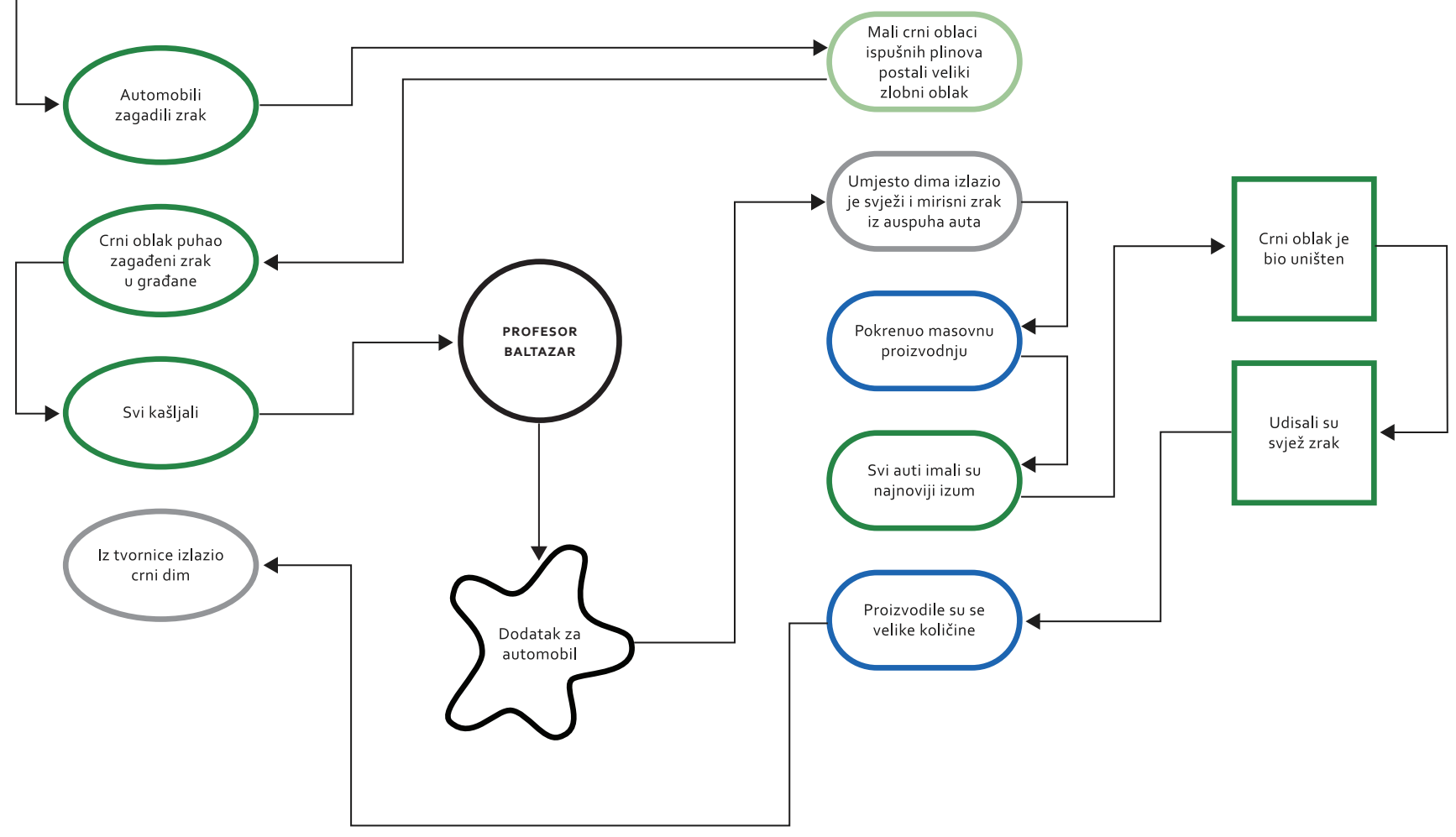

Augustova treća sreća

