

Električna shema CNC glodalice

Šignjar, Lovro

Supplement / Prilog

Publication year / Godina izdavanja: **2021**

Permanent link / Trajna poveznica: <https://urn.nsk.hr/urn:nbn:hr:122:740235>

Rights / Prava: [In copyright](#) / [Zaštićeno autorskim pravom](#).

Download date / Datum preuzimanja: **2025-02-07**



Repository / Repozitorij:

[University North Digital Repository](#)

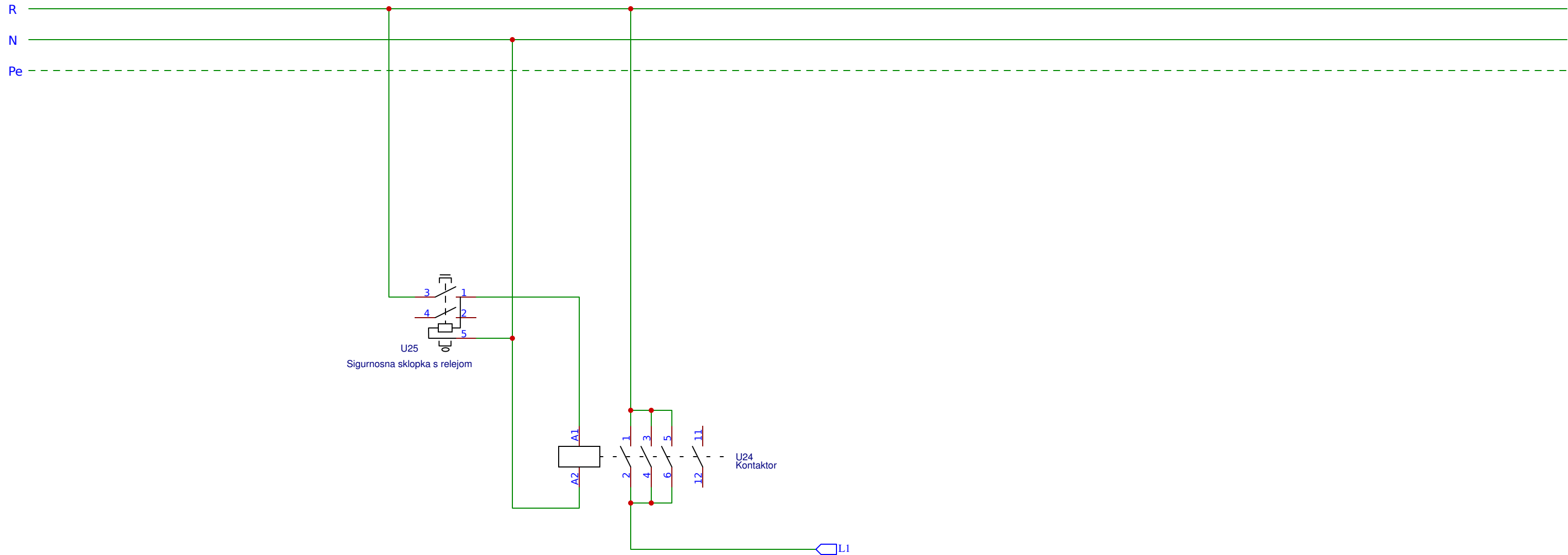

TITLE:	Upravljenje napajenjm	REV:	1.0	
	Company:	Sveučilište Sjever, Varaždin	Sheet:	1/8
	Date:	18.8.2021.	Drawn By:	Lovro Šignjar

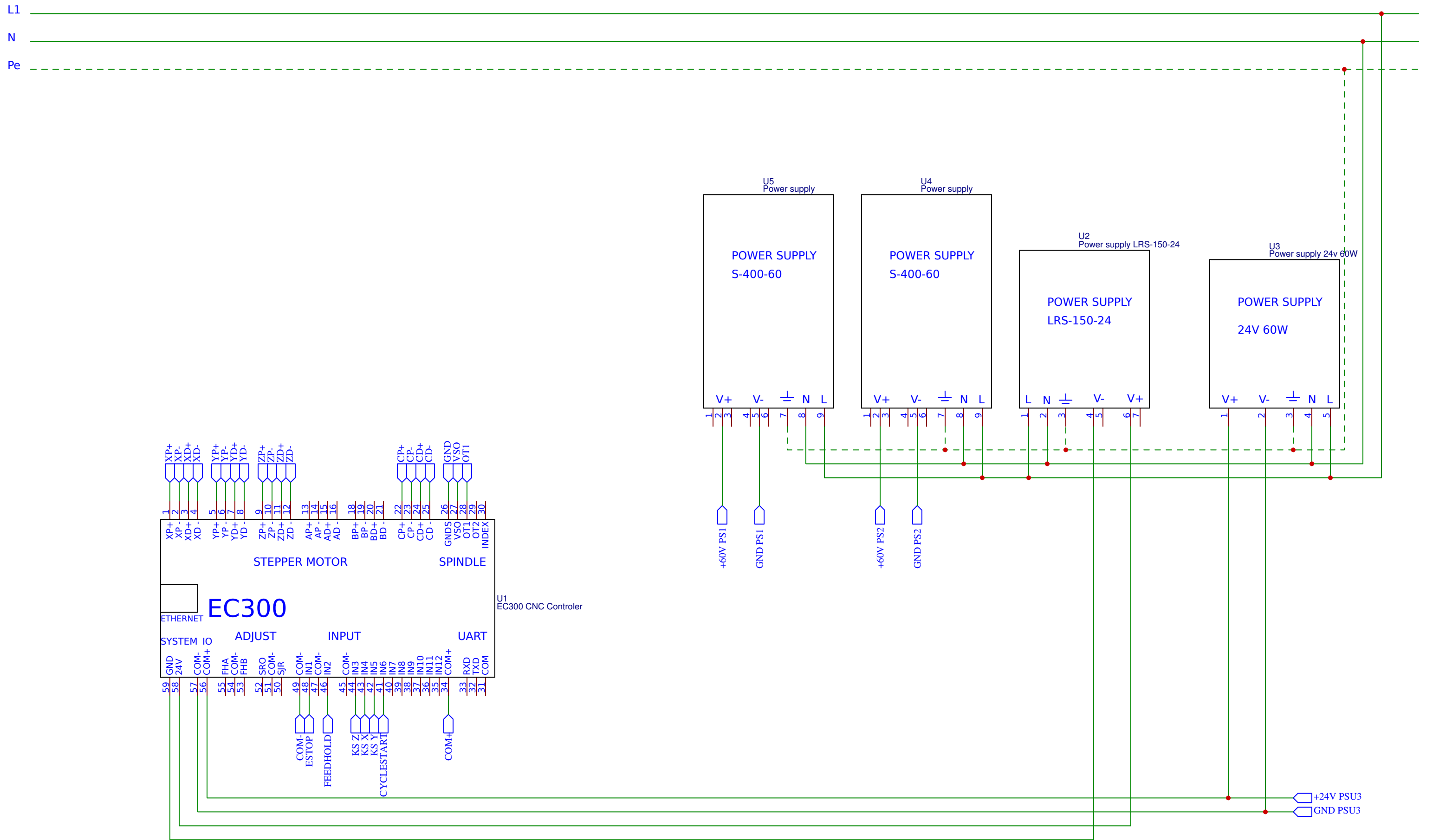

TITLE: Upravljački krug i napajanja		REV: 1.0
	Company: Sveučilište Sjever, Varaždin	Sheet: 2/8
	Date: 18.8.2021. Drawn By: Lovro Šignjar	

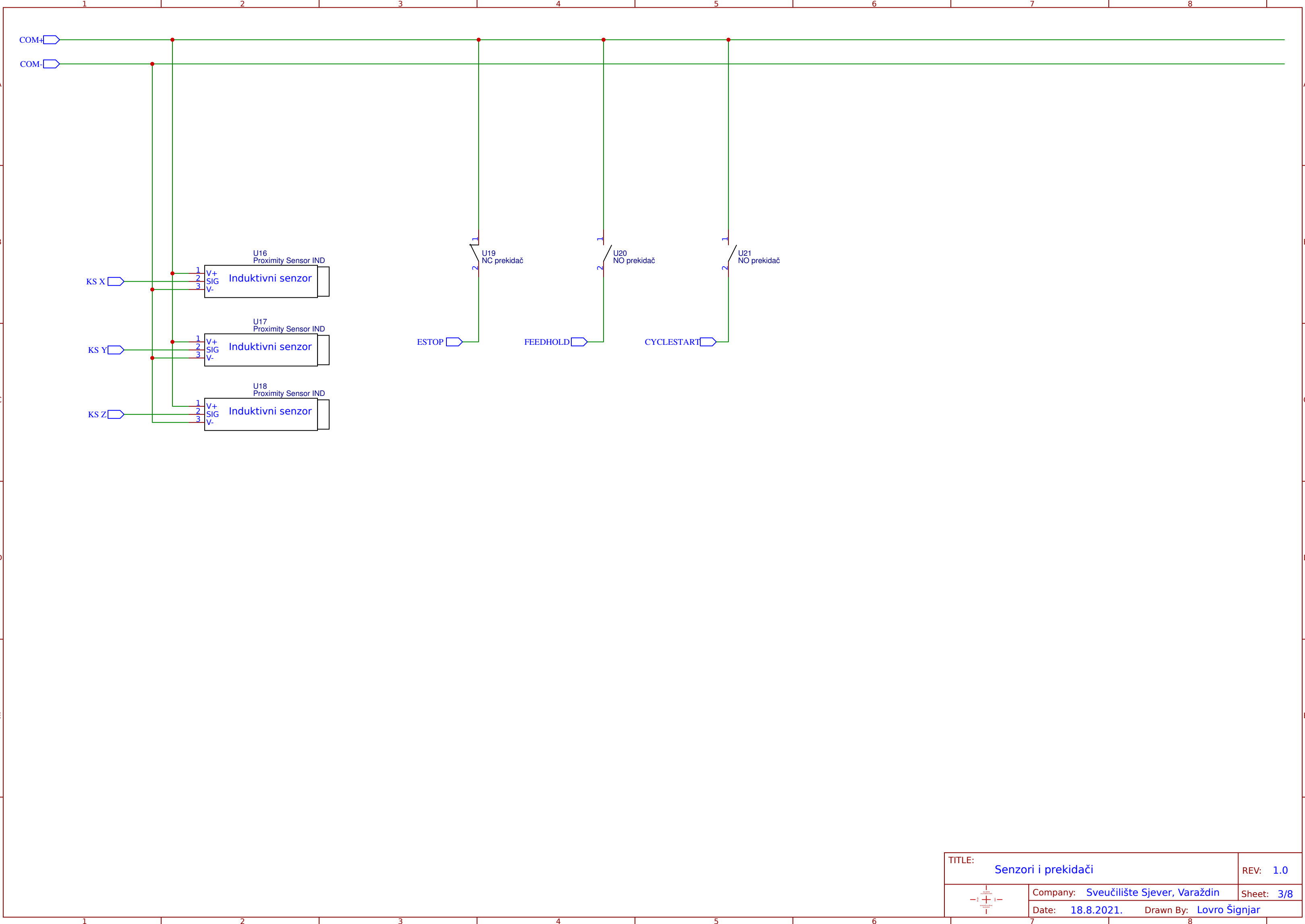

TITLE: Senzori i prekidači		REV: 1.0
	Company: Sveučilište Sjever, Varaždin	Sheet: 3/8
	Date: 18.8.2021.	Drawn By: Lovro Šignjar

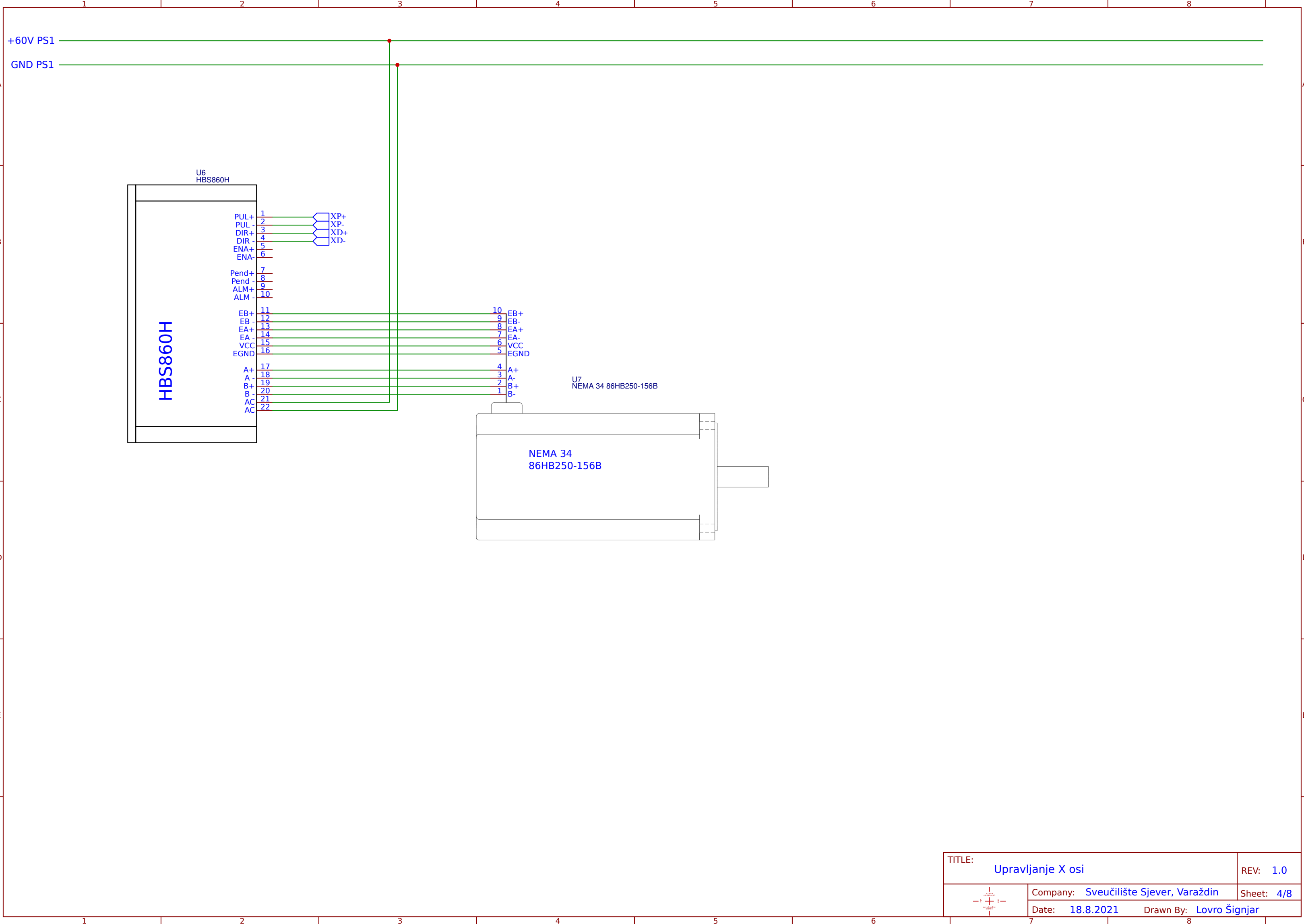

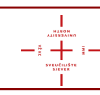
TITLE:	Upravljanje X osi	REV: 1.0
	Company: Sveučilište Sjever, Varaždin	Sheet: 4/8
	Date: 18.8.2021	Drawn By: Lovro Šignjar

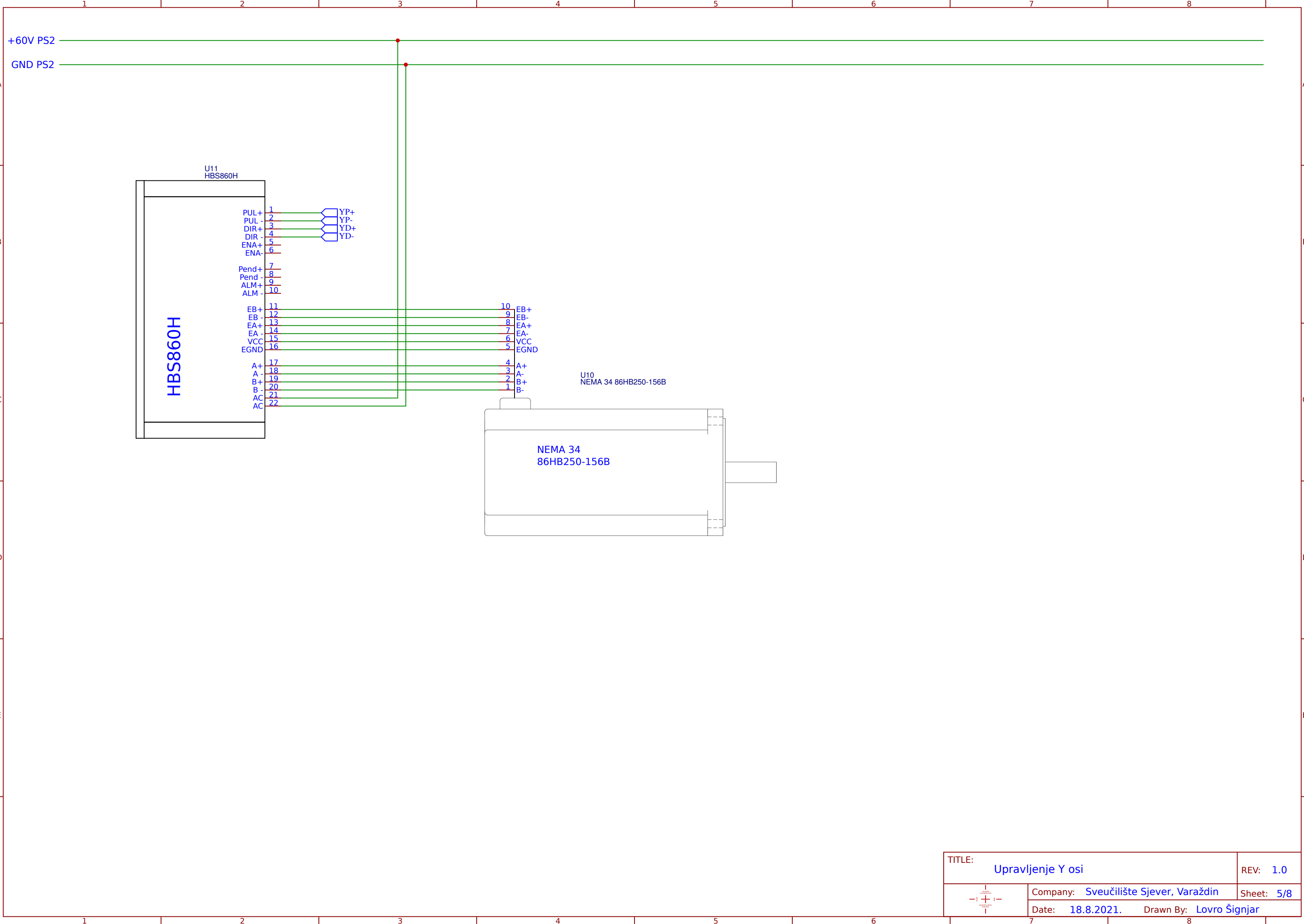

TITLE: Upravljenje Y osi		REV: 1.0
	Company: Sveučilište Sjever, Varaždin	Sheet: 5/8
	Date: 18.8.2021.	Drawn By: Lovro Šignjar

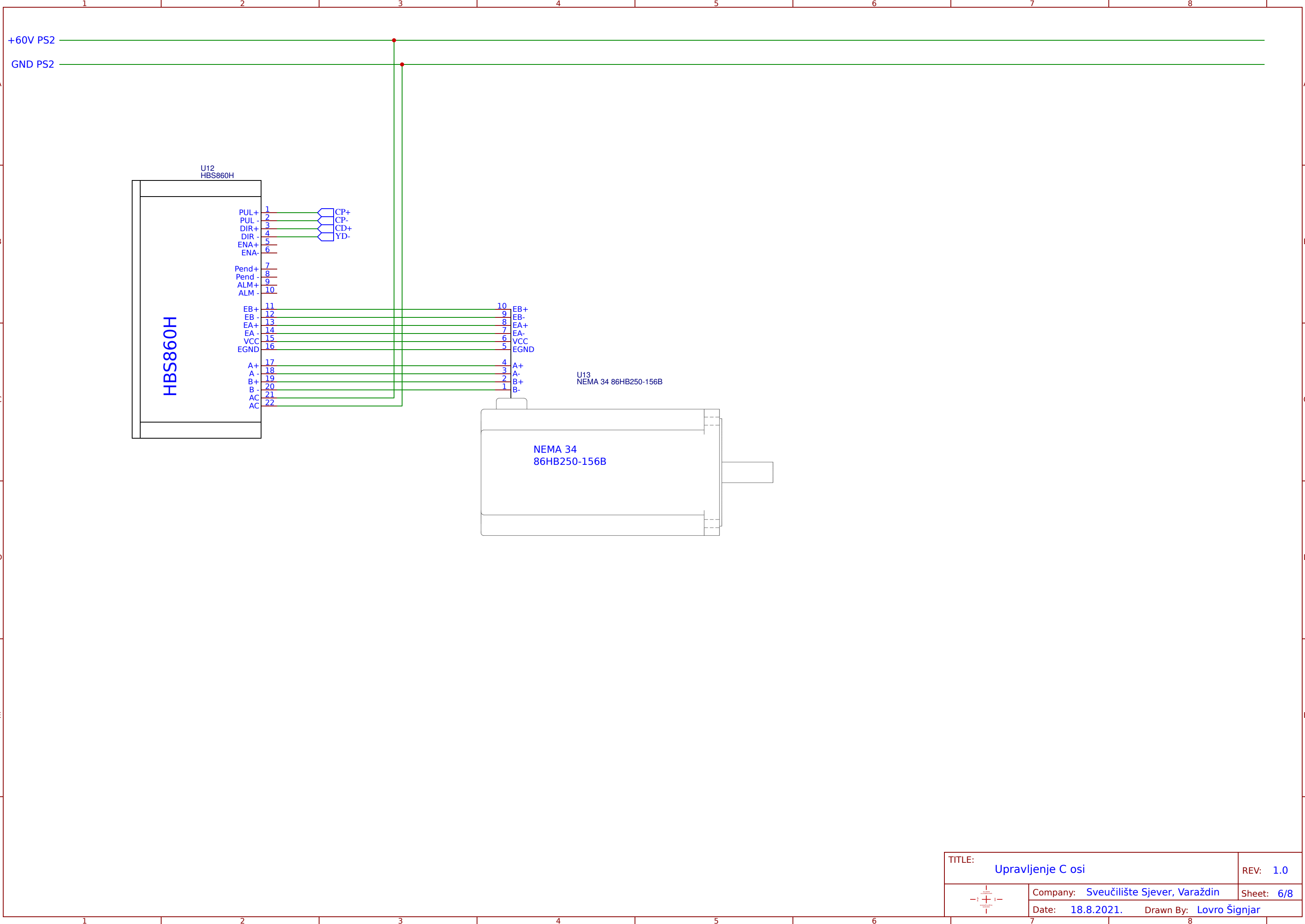

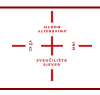
TITLE: Upravljenje C osi		REV: 1.0
	Company: Sveučilište Sjever, Varaždin	Sheet: 6/8
	Date: 18.8.2021.	Drawn By: Lovro Šignjar

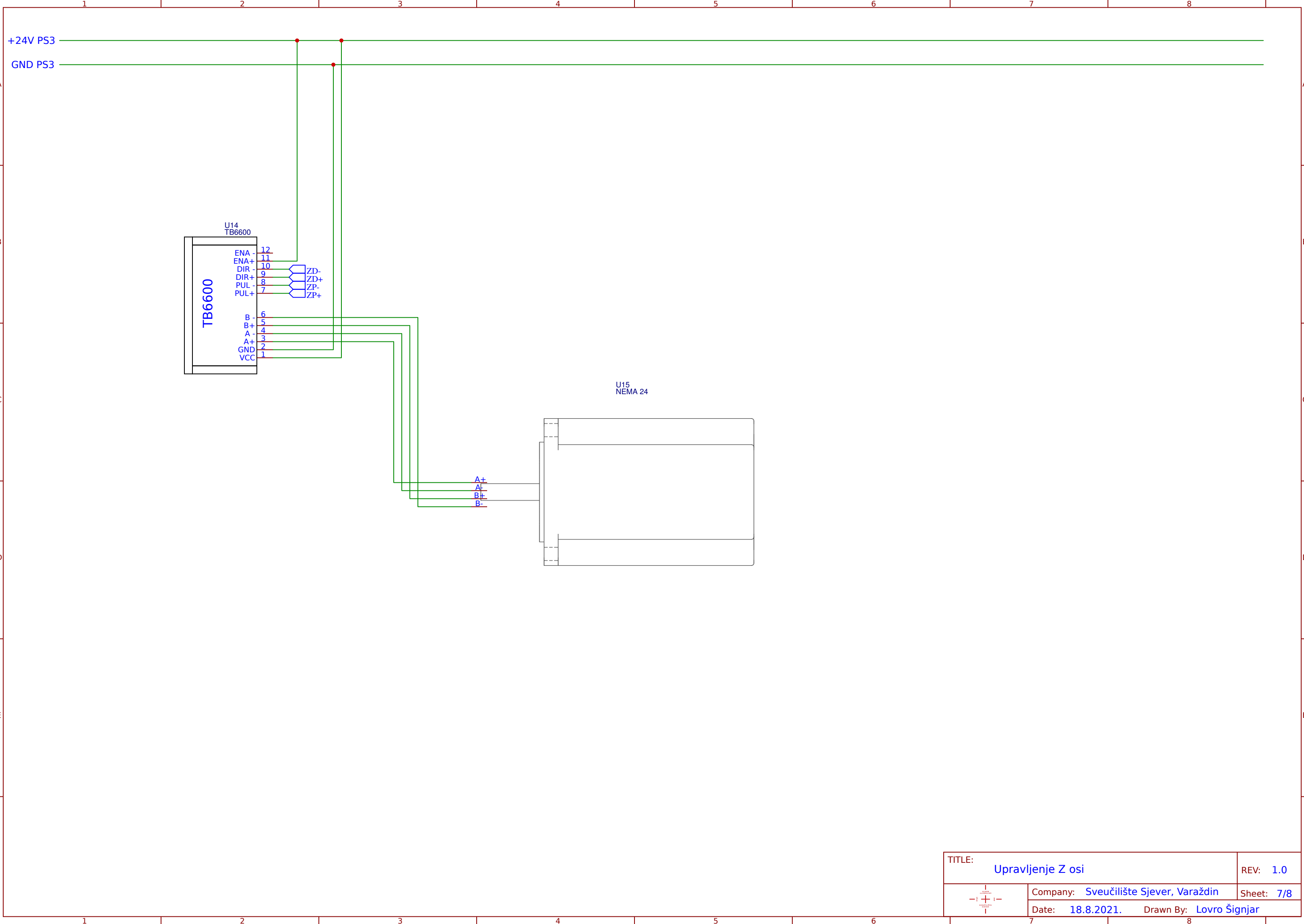

TITLE: Upravljenje Z osi		REV: 1.0
	Company: Sveučilište Sjever, Varaždin	Sheet: 7/8
	Date: 18.8.2021.	Drawn By: Lovro Šignjar

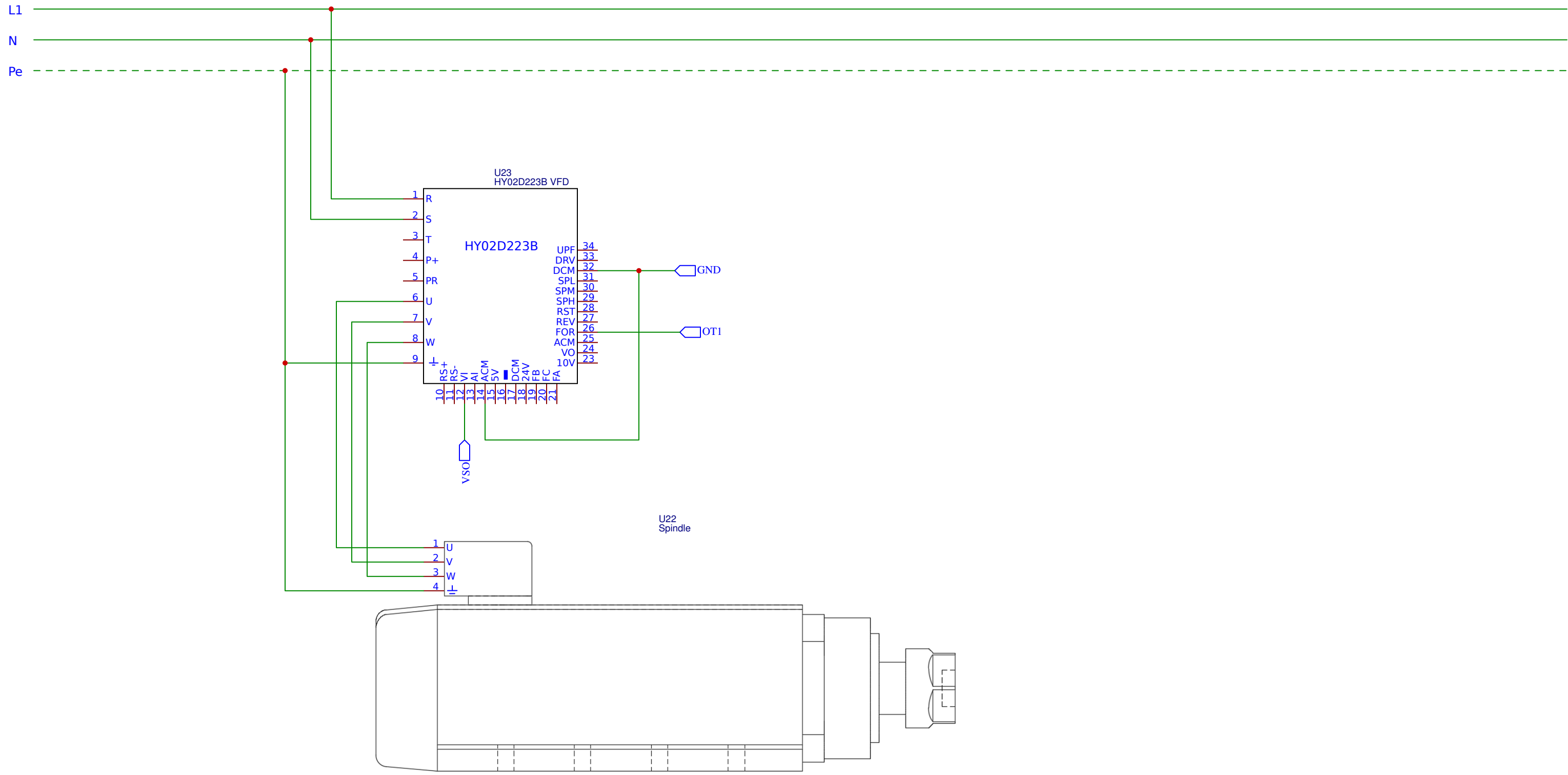

TITLE: Upravljenje glodalicom		REV: 1.0
	Company: Sveučilište Sjever, Varaždin	Sheet: 8/8
	Date: 18.8.2021.	Drawn By: Lovro Šignjar