

# Slika

---

**Bogdan, David**

**Supplement / Prilog**

*Publication year / Godina izdavanja:* **2016**

*Permanent link / Trajna poveznica:* <https://urn.nsk.hr/urn:nbn:hr:122:397095>

*Rights / Prava:* [In copyright](#)/[Zaštićeno autorskim pravom.](#)

*Download date / Datum preuzimanja:* **2025-04-08**



*Repository / Repozitorij:*

[University North Digital Repository](#)

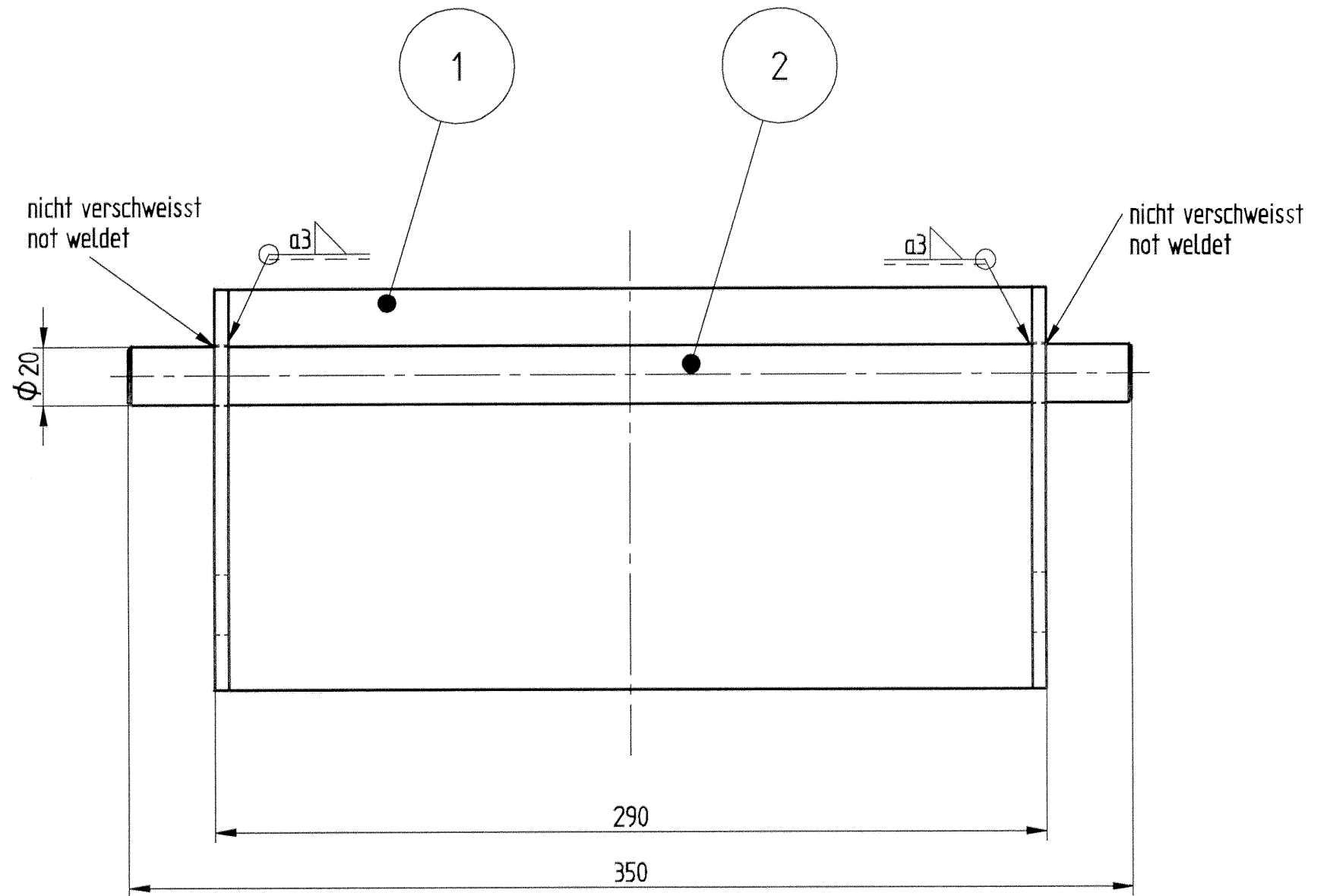
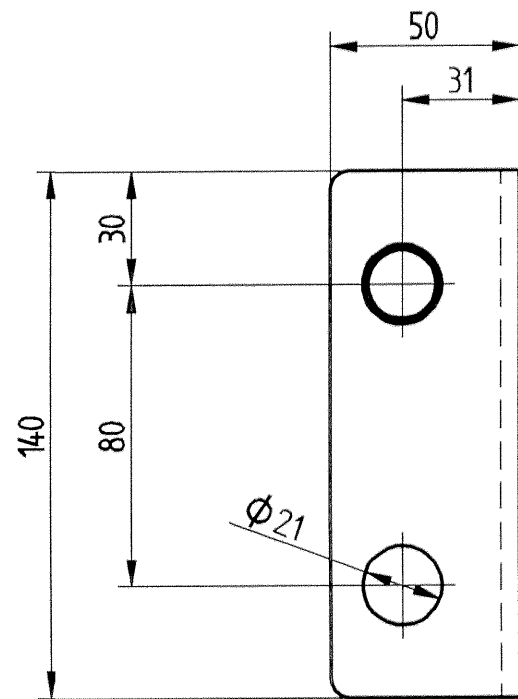

Allgemeintoleranzen siehe Werknorm 1.5 General Tolerances WN-No.: 1.5		Sicherheitsteil / Safety Part			
S1		S2		N	X

Ers. durch / REPL. BY:	Format / SIZE: <b>A3</b>	Datum/DATE: 11.04.05	Name/NAME: J.Richter	Werkstoff / MATERIAL:	Benennung / NAME: Halter <i>Pos. 5</i>	Dokumenteninfosatz-Nr. / DIS NO: 1000041550	Material-Nr. / PART NO: 10214372
Ers. für / REPL. FOR:	Gezeichnet / DRAWN BY:			Werkst.Nr. / MATERIAL CODE:		Version: 01	Datum / DATE: 13.04.06
Ung.-Datum/EXPIRY DATE:	Geprüft / CHECKED BY:			Gewicht / WEIGHT (kg): 2,83	bracket <i>Rohrmast 6m</i>	Name / NAME: J.Richter	Blatt-Nr. / SHEET:
Normgeprüft / APPROVED BY: 13.4-06 <i>Günter J.</i>		Schutzvermerk DIN 34-1-D Copyright reserved Schwing GmbH		Maßstab / SCALE: 1:2	DO NOT SCALE / Nicht abmessen		<b>SCHWING</b>