

# Električna shema CNC glodalice

---

Šignjar, Lovro

## Supplement / Prilog

Publication year / Godina izdavanja: **2021**

Permanent link / Trajna poveznica: <https://urn.nsk.hr/urn:nbn:hr:122:740235>

Rights / Prava: [In copyright](#)/[Zaštićeno autorskim pravom.](#)

Download date / Datum preuzimanja: **2025-01-21**



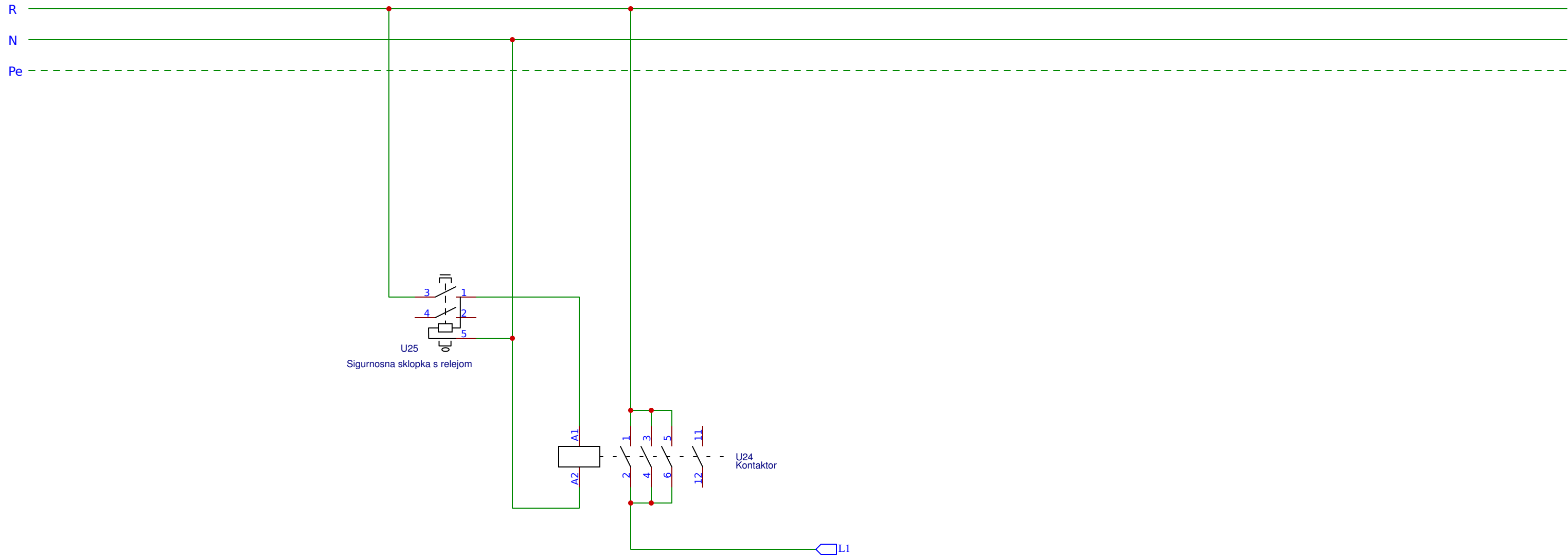

Repository / Repozitorij:

[University North Digital Repository](#)

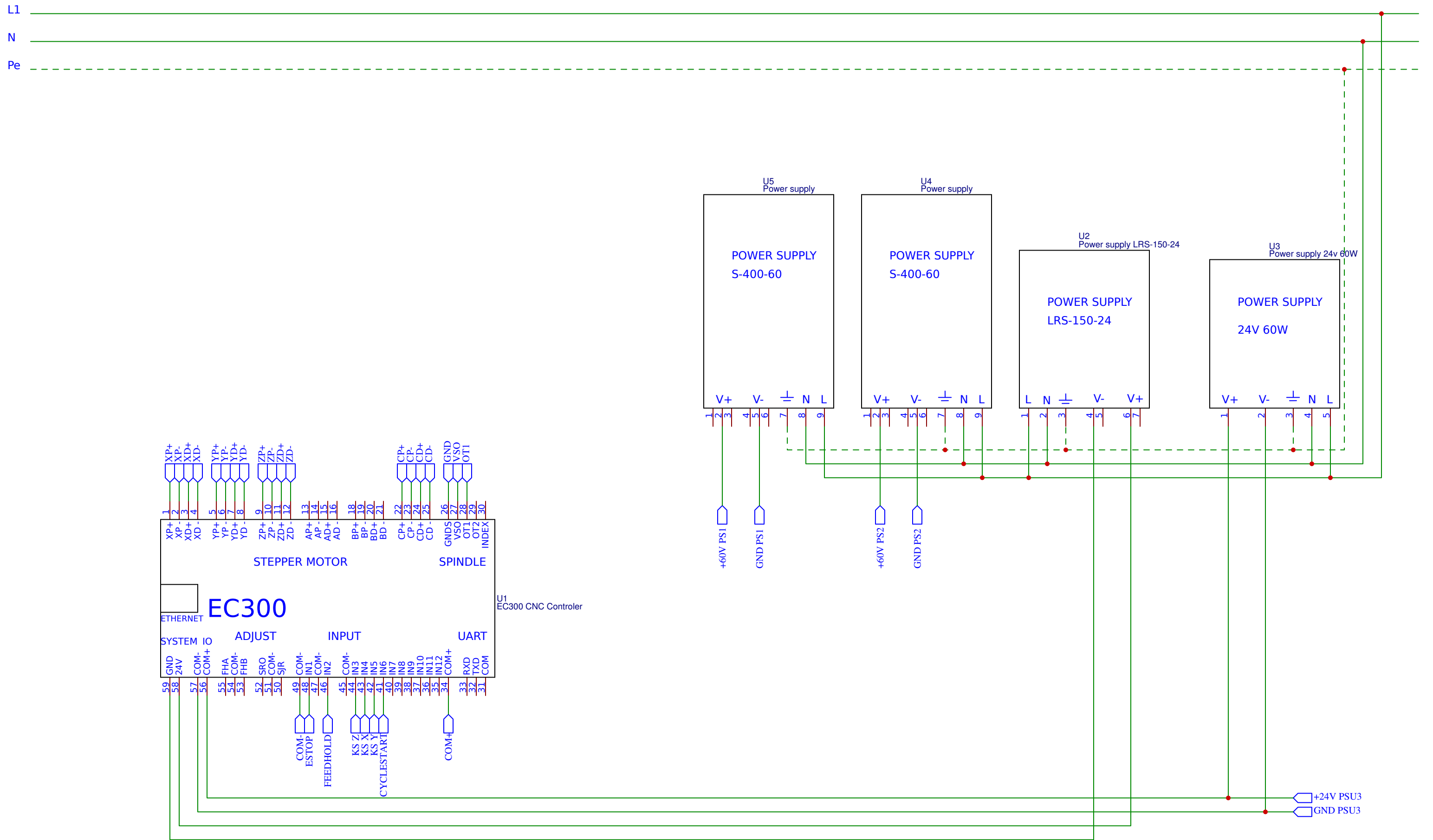

TITLE: <b>Upravljenje napajenjm</b>		REV: 1.0
	Company: Sveučilište Sjever, Varaždin	Sheet: 1/8
	Date: 18.8.2021.	Drawn By: Lovro Šignjar



TITLE: <b>Upravljački krug i napajanja</b>		REV: 1.0
	Company: Sveučilište Sjever, Varaždin	Sheet: 2/8
	Date: 18.8.2021. Drawn By: Lovro Šignjar	

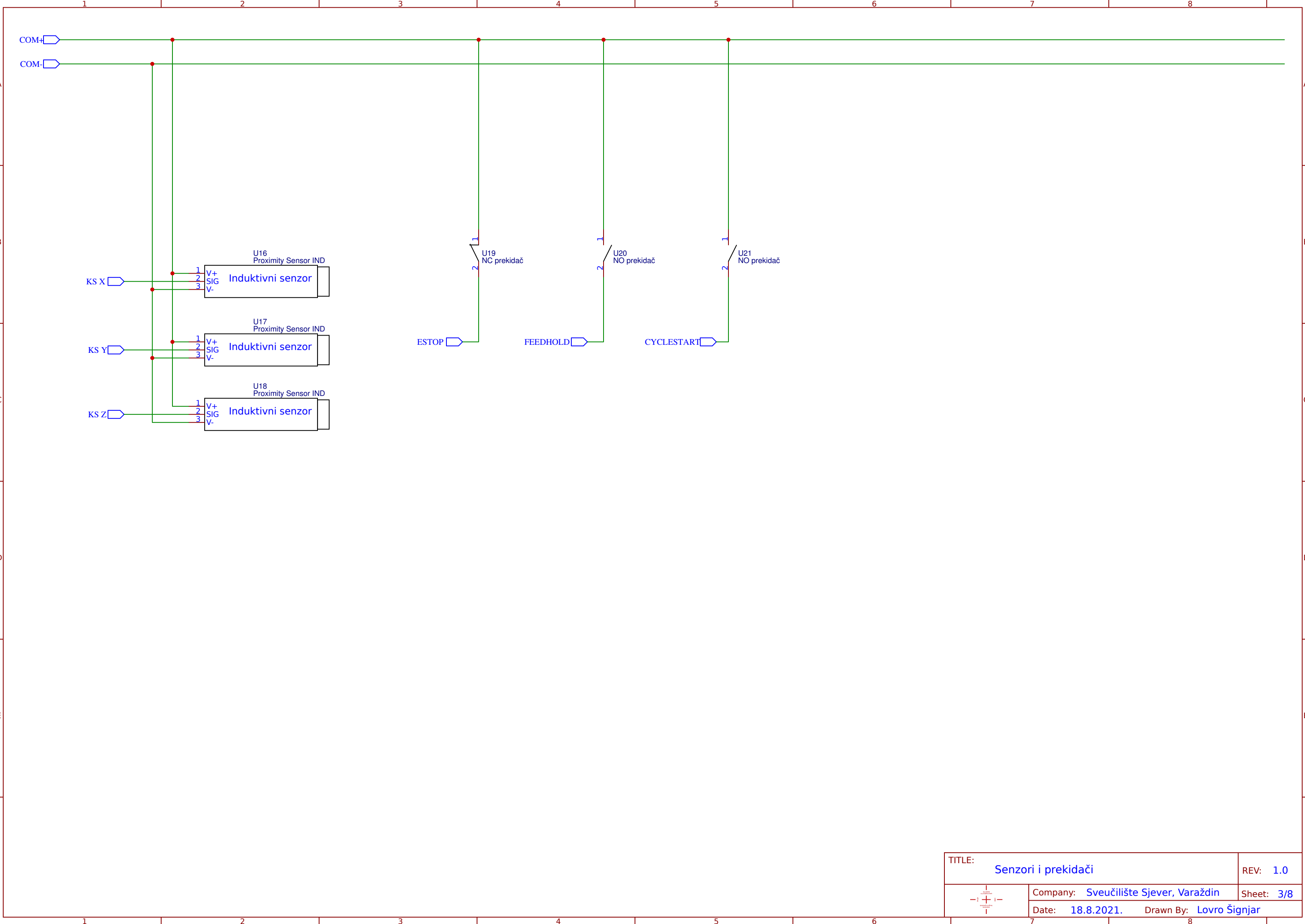

TITLE: <b>Senzori i prekidači</b>		REV: 1.0
	Company: Sveučilište Sjever, Varaždin	Sheet: 3/8
	Date: 18.8.2021.	Drawn By: Lovro Šignjar

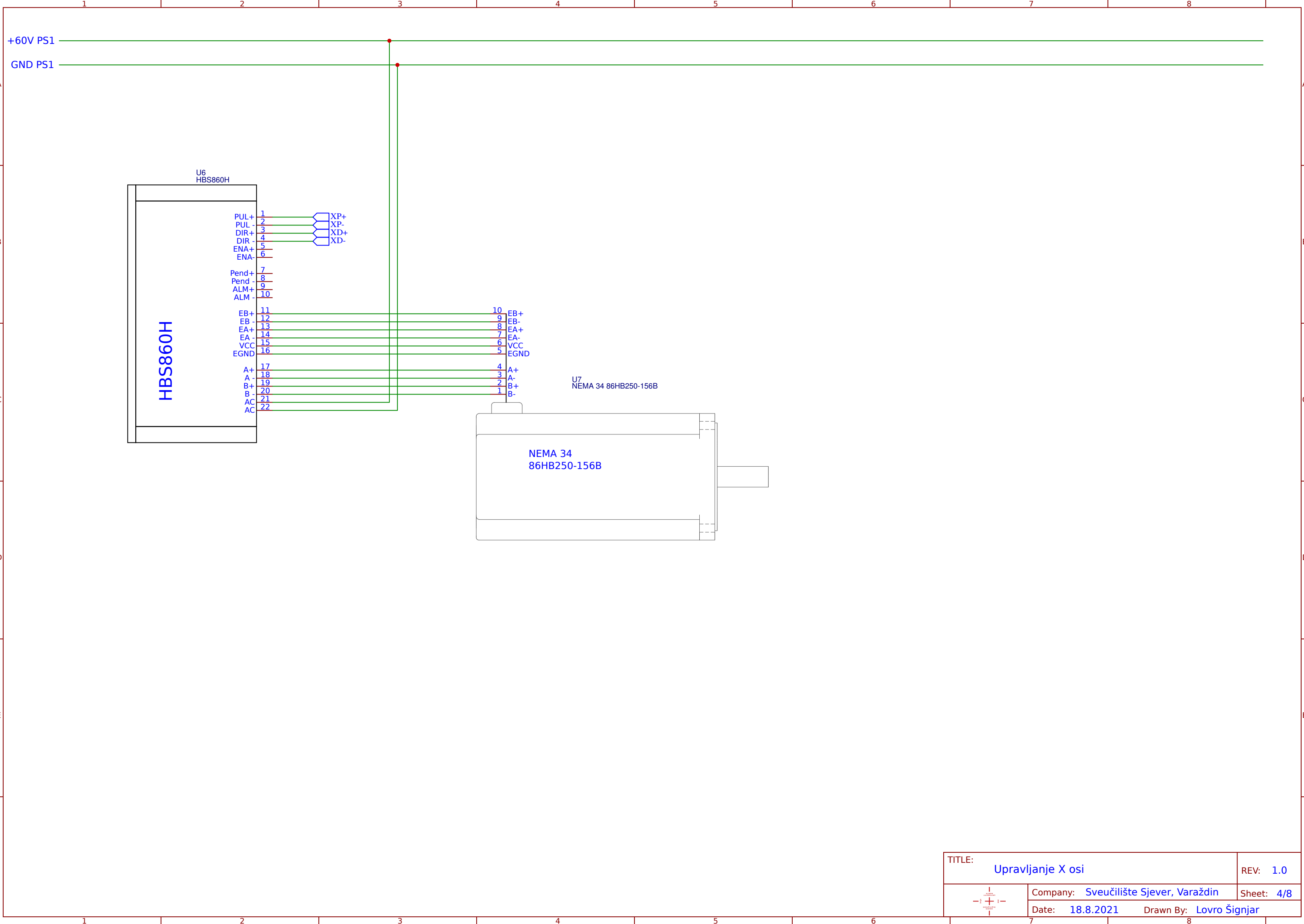

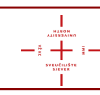
TITLE:	Upravljanje X osi	REV: 1.0
	Company: Sveučilište Sjever, Varaždin	Sheet: 4/8
	Date: 18.8.2021	Drawn By: Lovro Šignjar

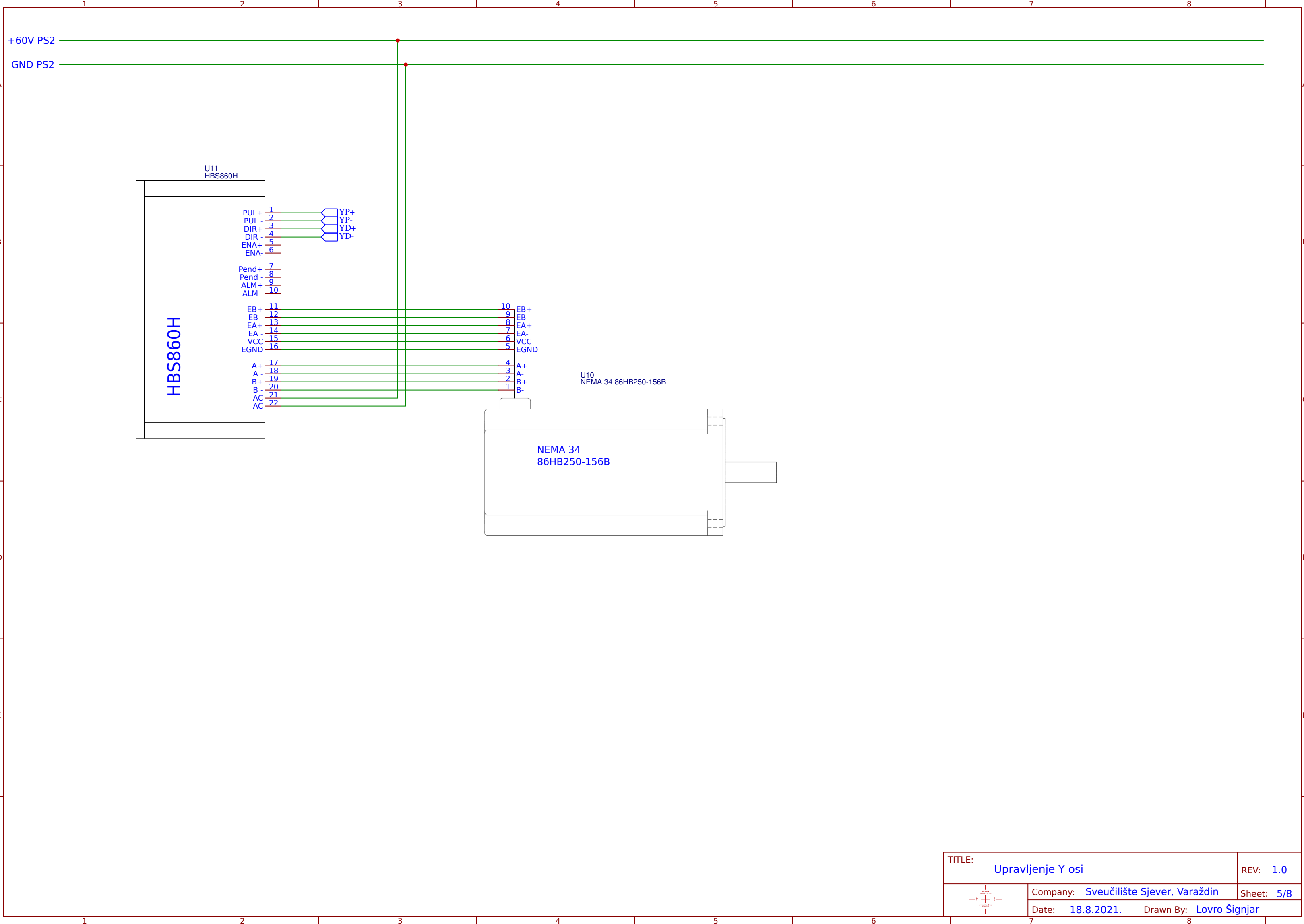

TITLE: <b>Upravljenje Y osi</b>		REV: <b>1.0</b>
	Company: <b>Sveučilište Sjever, Varaždin</b>	Sheet: <b>5/8</b>
	Date: <b>18.8.2021.</b>	Drawn By: <b>Lovro Šignjar</b>

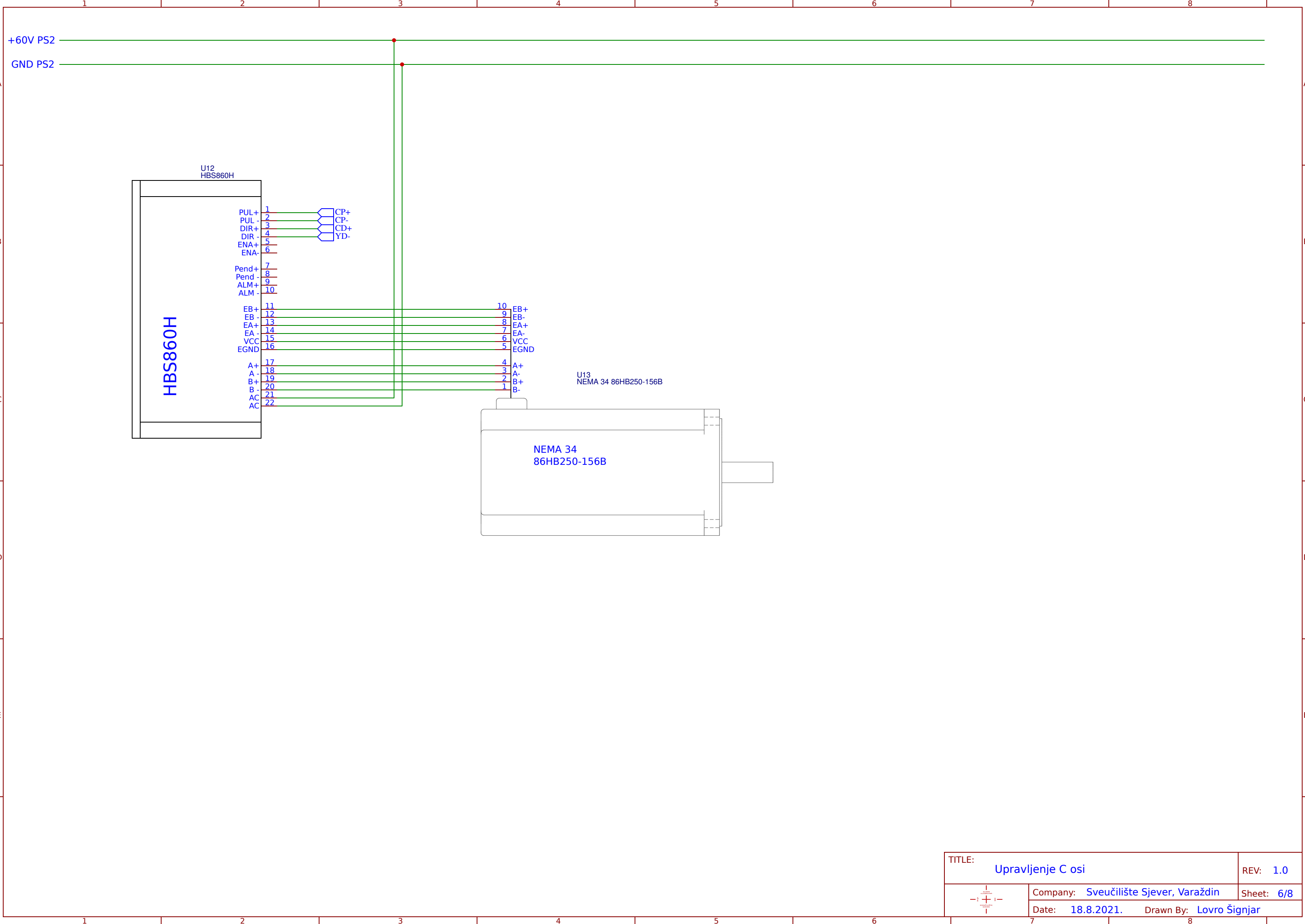

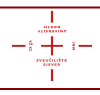
TITLE: <b>Upravljenje C osi</b>		REV: 1.0
	Company: Sveučilište Sjever, Varaždin	Sheet: 6/8
	Date: 18.8.2021.	Drawn By: Lovro Šignjar

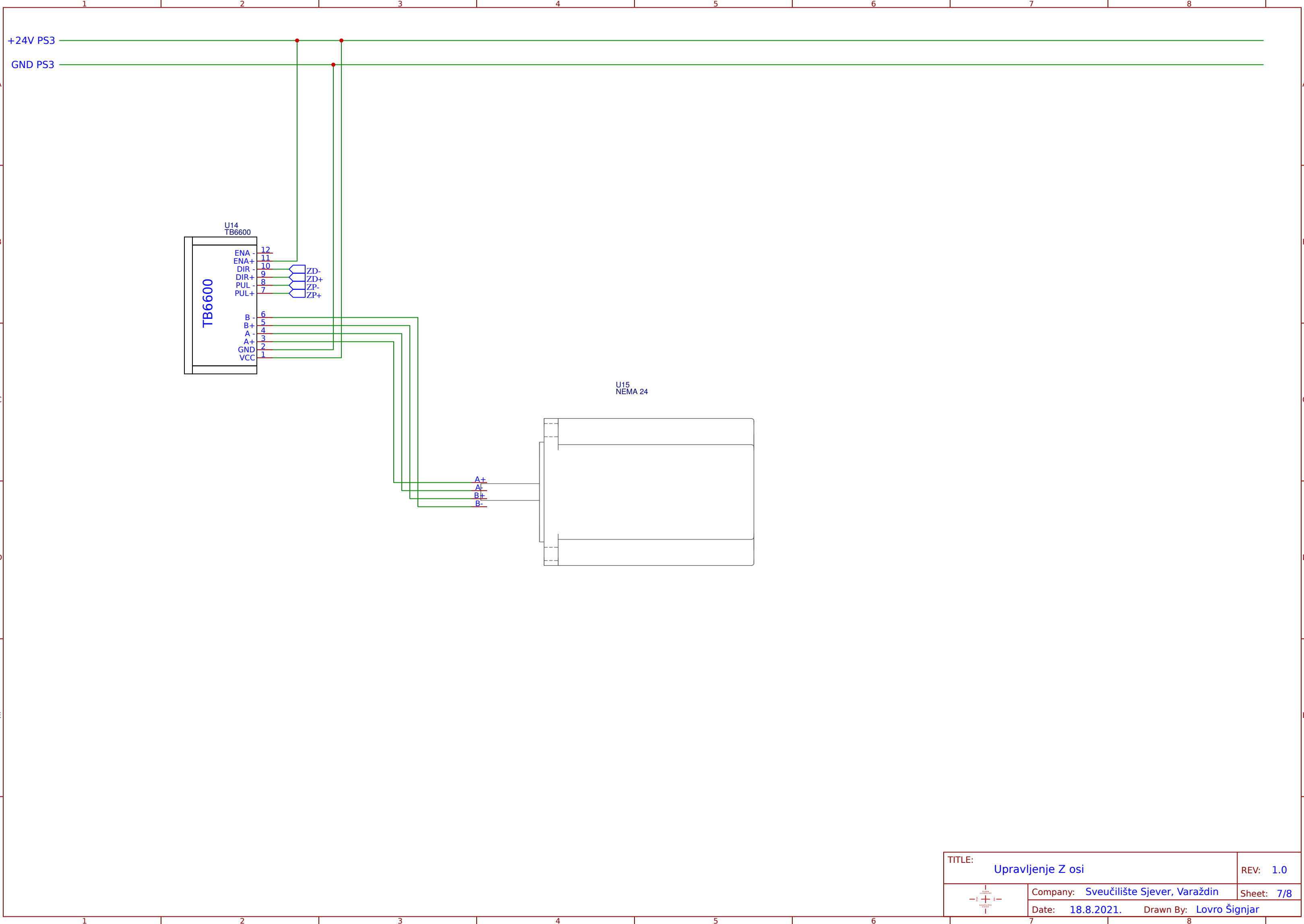

TITLE:	Upravljenje Z osi	REV: 1.0
	Company: Sveučilište Sjever, Varaždin	Sheet: 7/8
	Date: 18.8.2021.	Drawn By: Lovro Šignjar



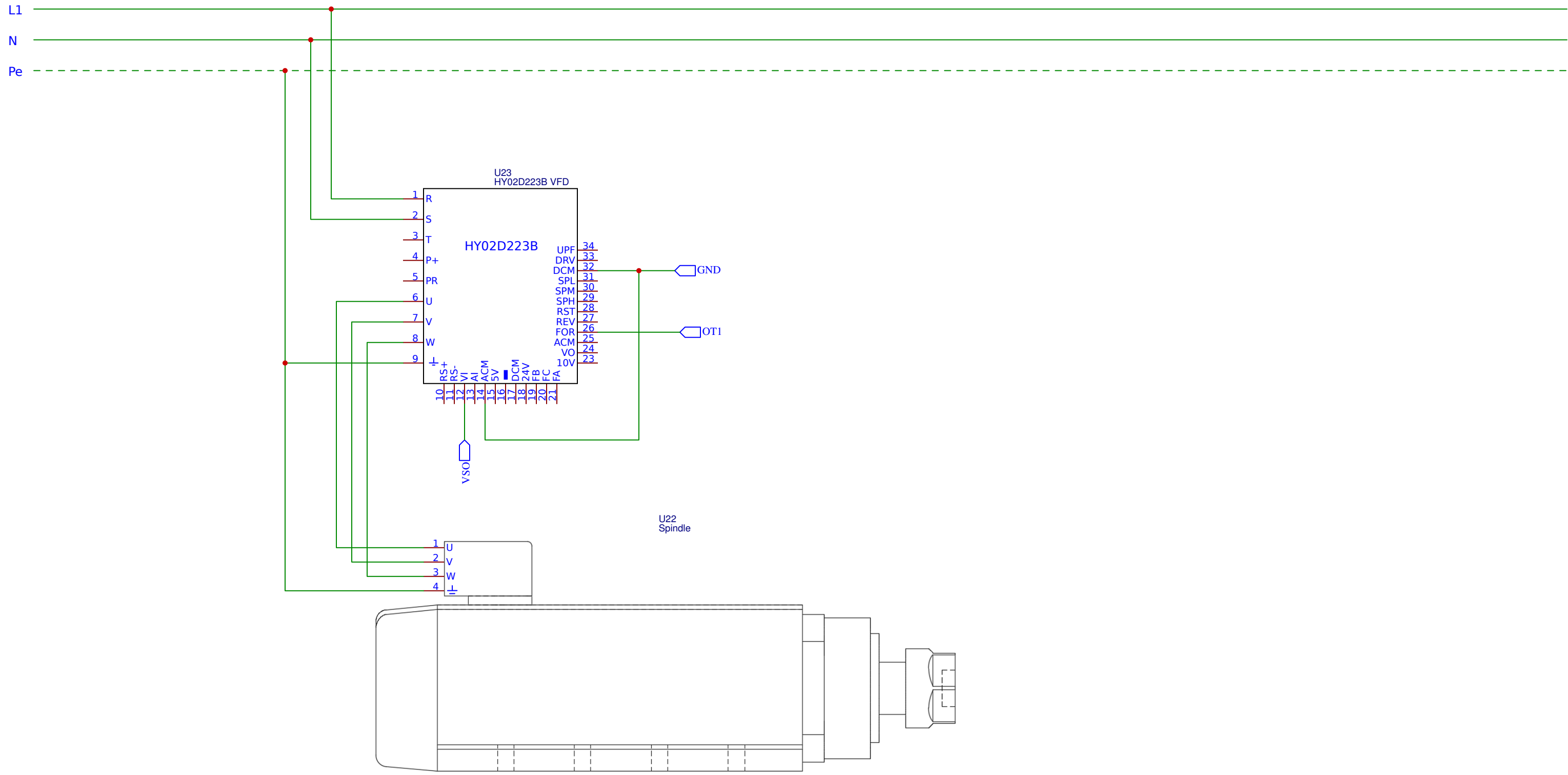

TITLE: <b>Upravljenje glodalicom</b>		REV: 1.0
	Company: Sveučilište Sjever, Varaždin	Sheet: 8/8
	Date: 18.8.2021.	Drawn By: Lovro Šignjar