

Električna shema CNC glodalice

Šignjar, Lovro

Supplement / Prilog

Publication year / Godina izdavanja: **2021**

Permanent link / Trajna poveznica: <https://urn.nsk.hr/urn:nbn:hr:122:740235>

Rights / Prava: [In copyright](#)/[Zaštićeno autorskim pravom.](#)

Download date / Datum preuzimanja: **2024-09-05**



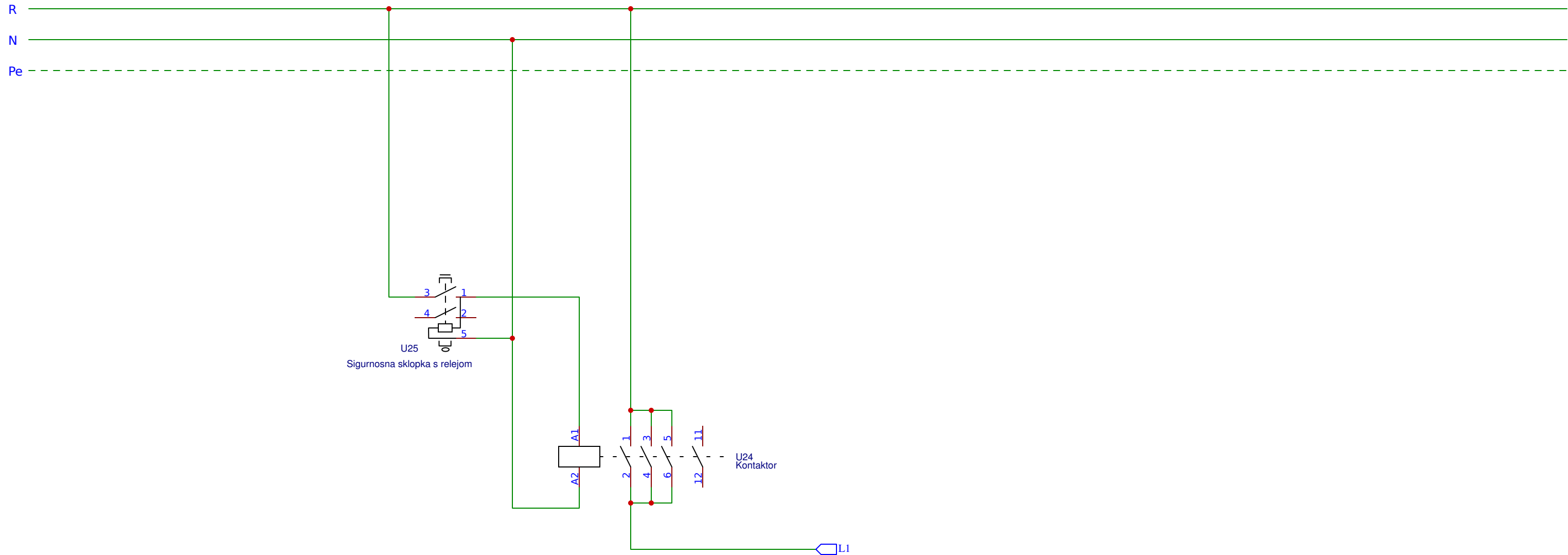

Repository / Repozitorij:

[University North Digital Repository](#)

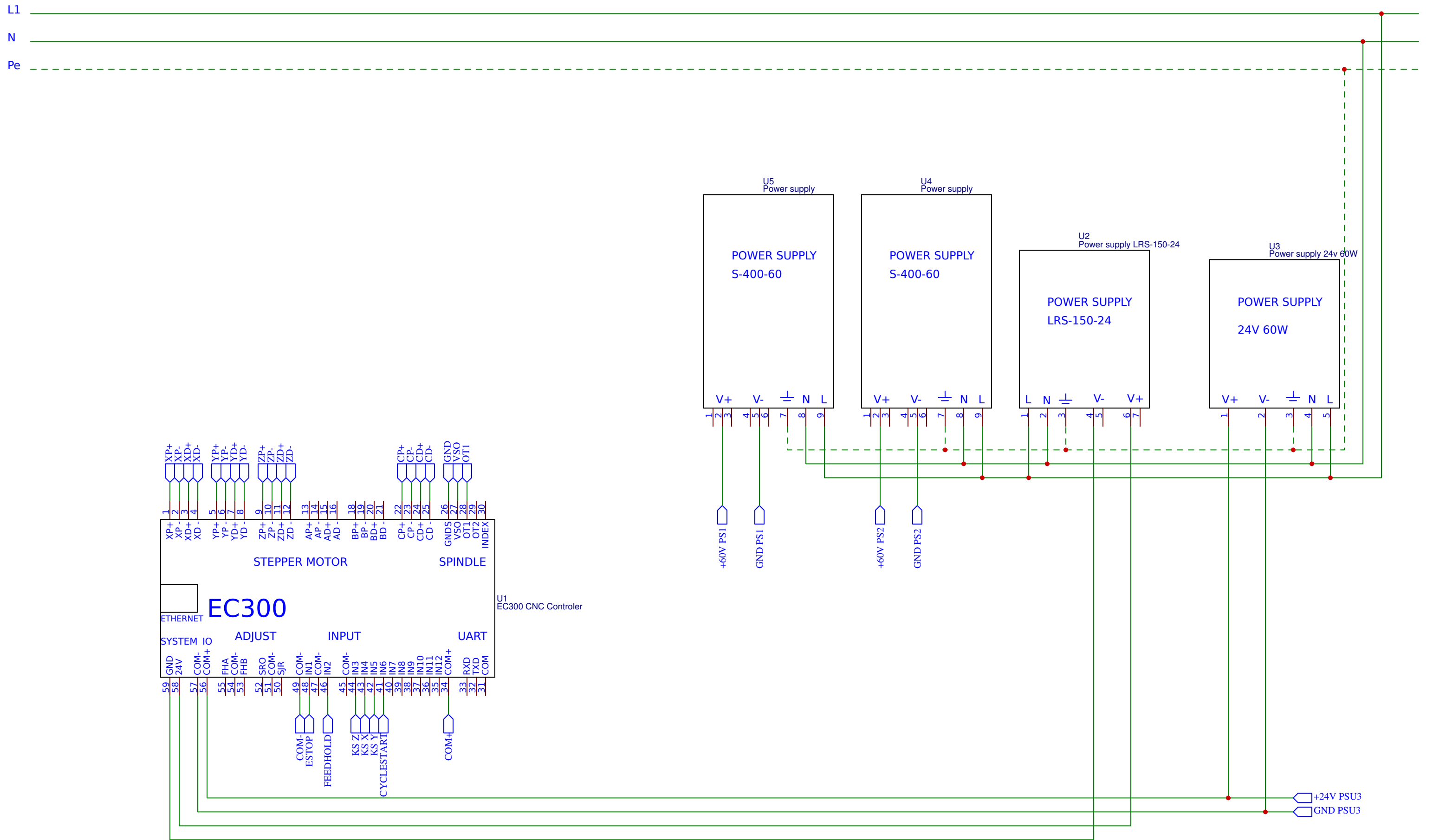

TITLE:	Upravljenje napajenjm	REV:	1.0	
	Company:	Sveučilište Sjever, Varaždin	Sheet:	1/8
	Date:	18.8.2021.	Drawn By:	Lovro Šignjar



TITLE: Upravljački krug i napajanja		REV: 1.0
	Company: Sveučilište Sjever, Varaždin	Sheet: 2/8
	Date: 18.8.2021. Drawn By: Lovro Šignjar	

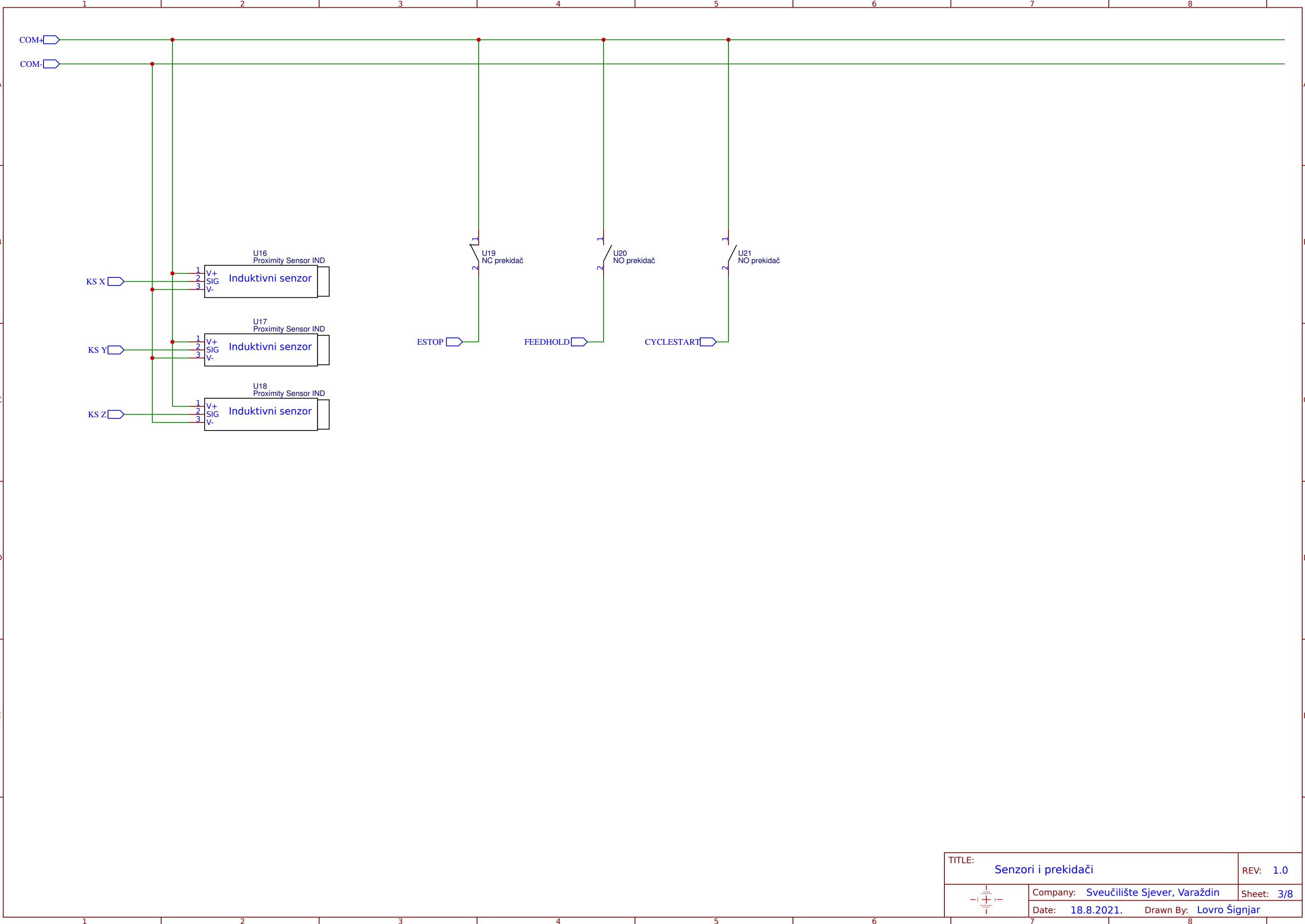

TITLE:	Senzori i prekidači	REV:	1.0	
	Company:	Sveučilište Sjever, Varaždin	Sheet:	3/8
	Date:	18.8.2021.	Drawn By:	Lovro Šignjar

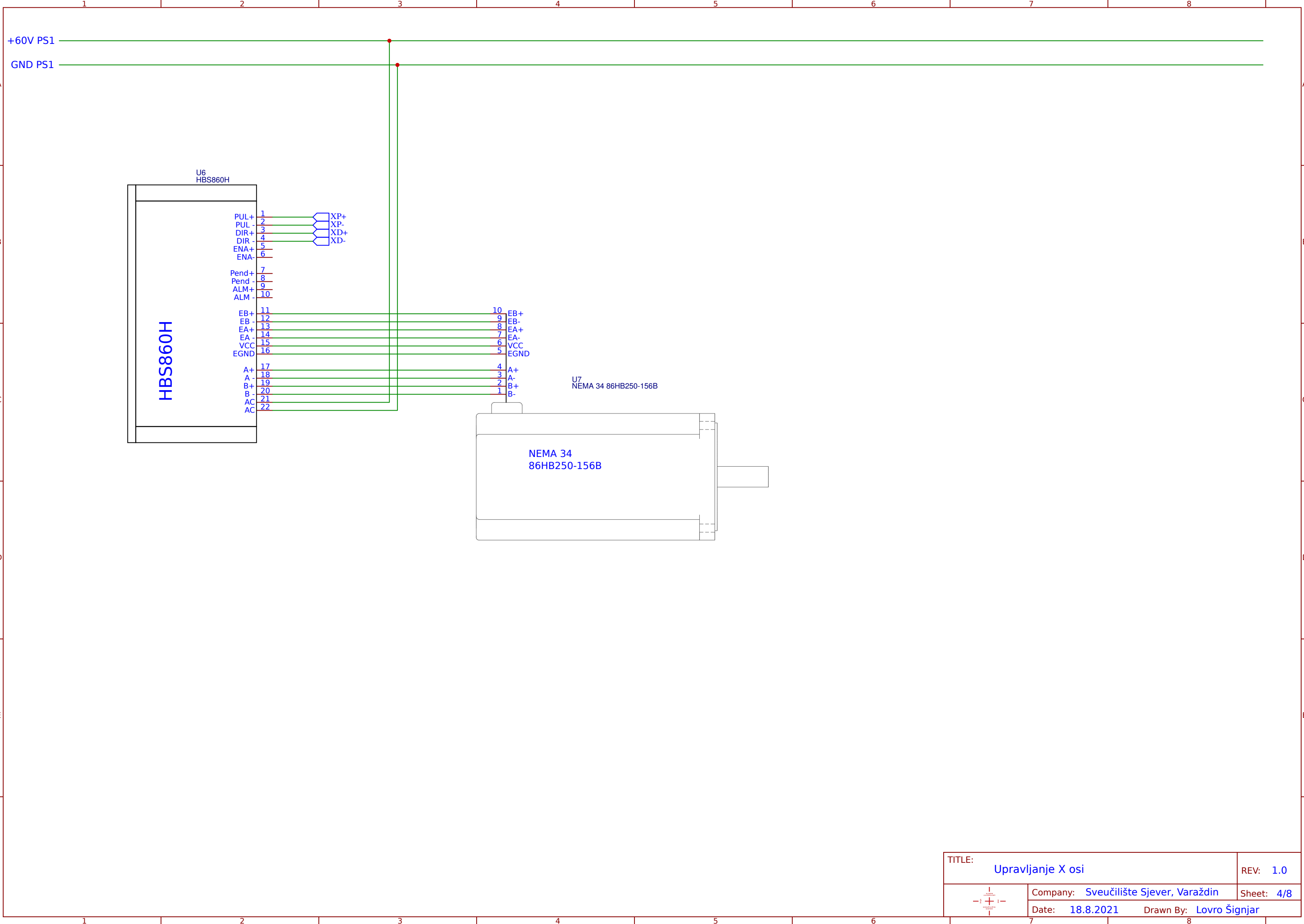

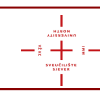
TITLE:	Upravljanje X osi	REV: 1.0
	Company: Sveučilište Sjever, Varaždin	Sheet: 4/8
	Date: 18.8.2021	Drawn By: Lovro Šignjar

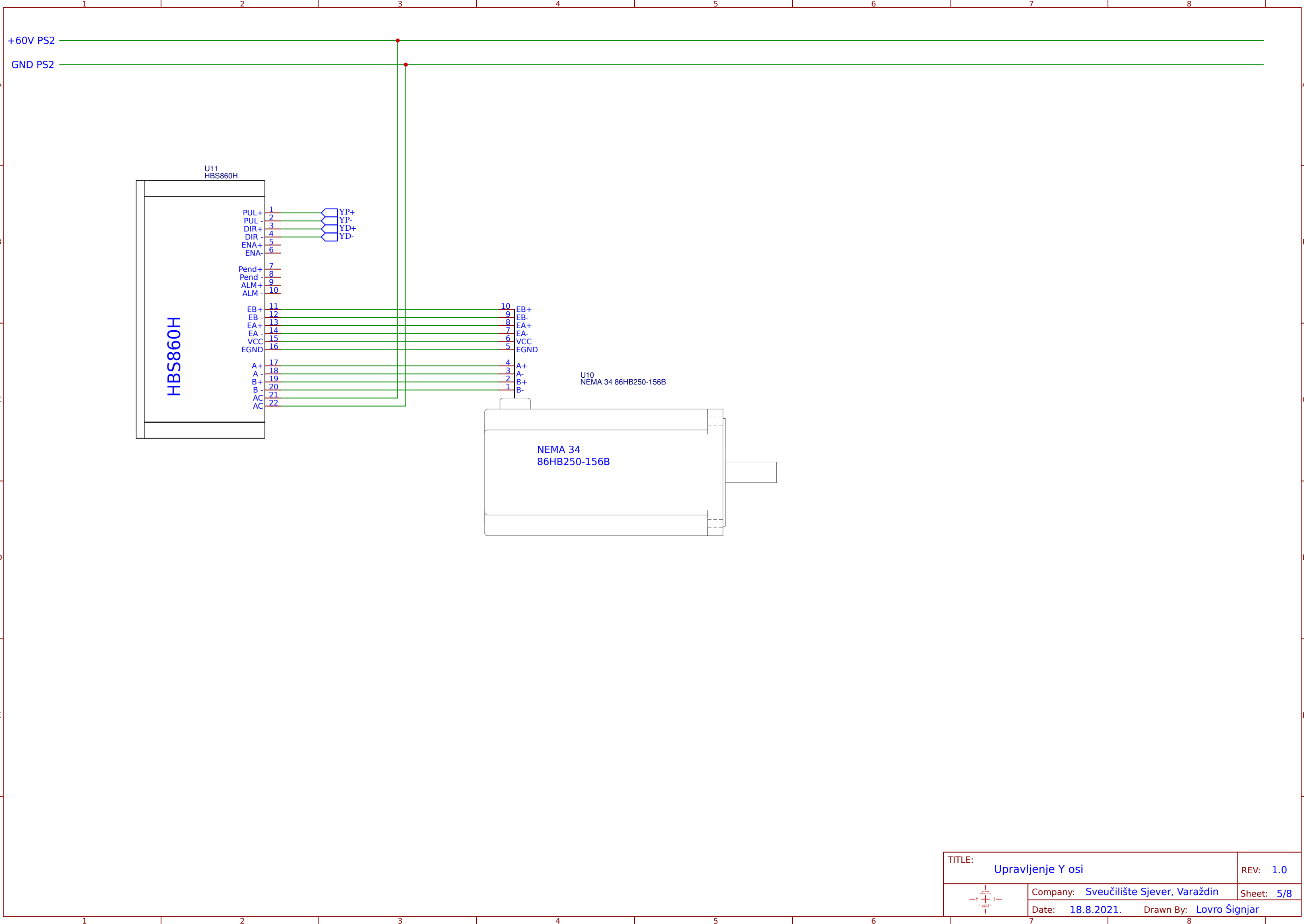

+60V PS2

GND PS2

U11
HBS860H

- 1 PUL+
- 2 PUL-
- 3 DIR+
- 4 DIR-
- 5 ENA+
- 6 ENA-
- 7 Pend+
- 8 Pend-
- 9 ALM+
- 10 ALM-
- 11 EB+
- 12 EB-
- 13 EA+
- 14 EA-
- 15 VCC
- 16 EGND
- 17 A+
- 18 A-
- 19 B+
- 20 B-
- 21 AC
- 22 AC

- YP+
- YP-
- YD+
- YD-

- 10 EB+
- 9 EB-
- 8 EA+
- 7 EA-
- 6 VCC
- 5 EGND
- 4 A+
- 3 A-
- 2 B+
- 1 B-

U10
NEMA 34 86HB250-156B

NEMA 34
86HB250-156B

TITLE: Upravljenje Y osi		REV: 1.0
	Company: Sveučilište Sjever, Varaždin	Sheet: 5/8
	Date: 18.8.2021.	Drawn By: Lovro Šignjar

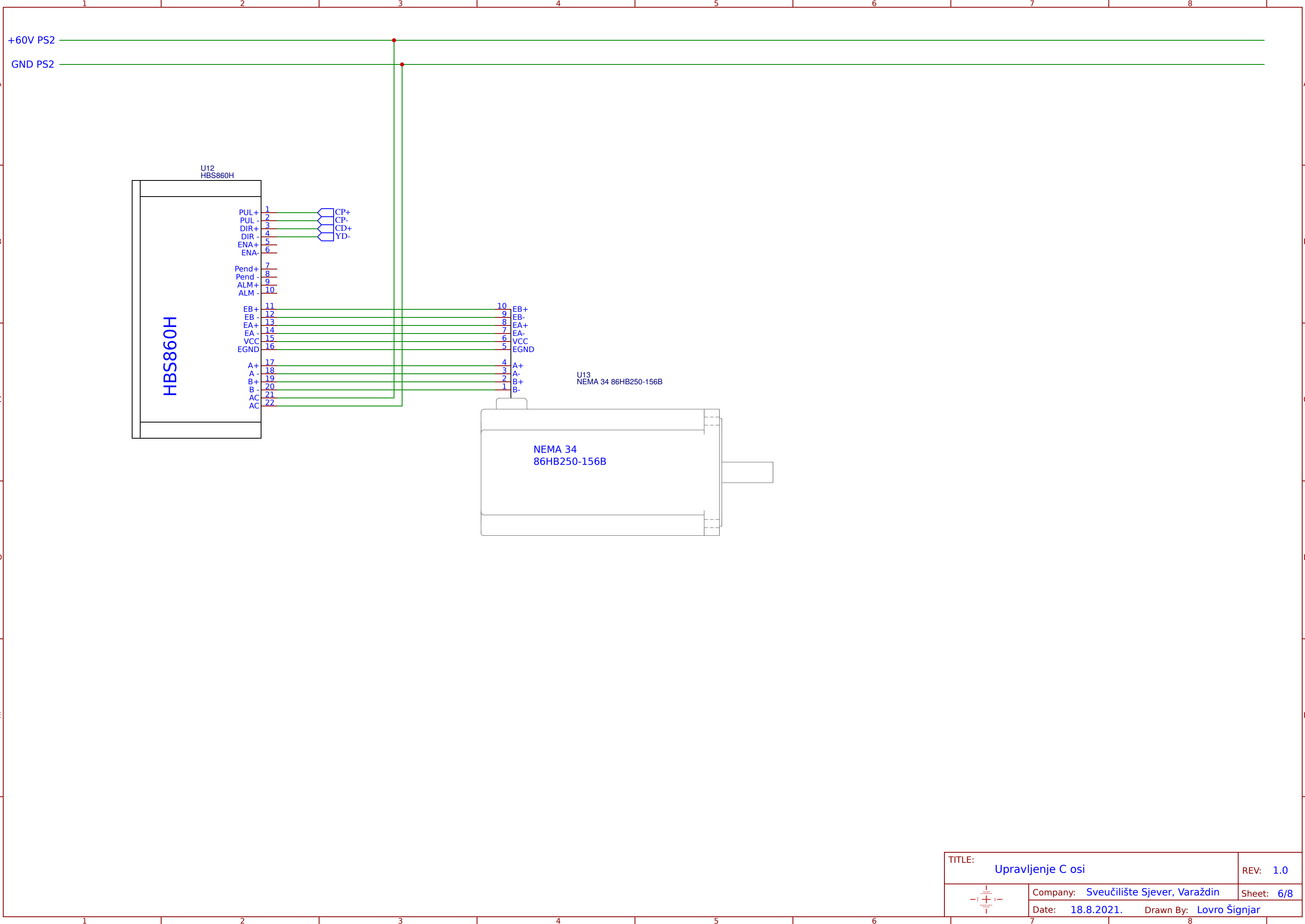

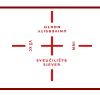
TITLE: Upravljenje C osi		REV: 1.0
	Company: Sveučilište Sjever, Varaždin	Sheet: 6/8
	Date: 18.8.2021.	Drawn By: Lovro Šignjar

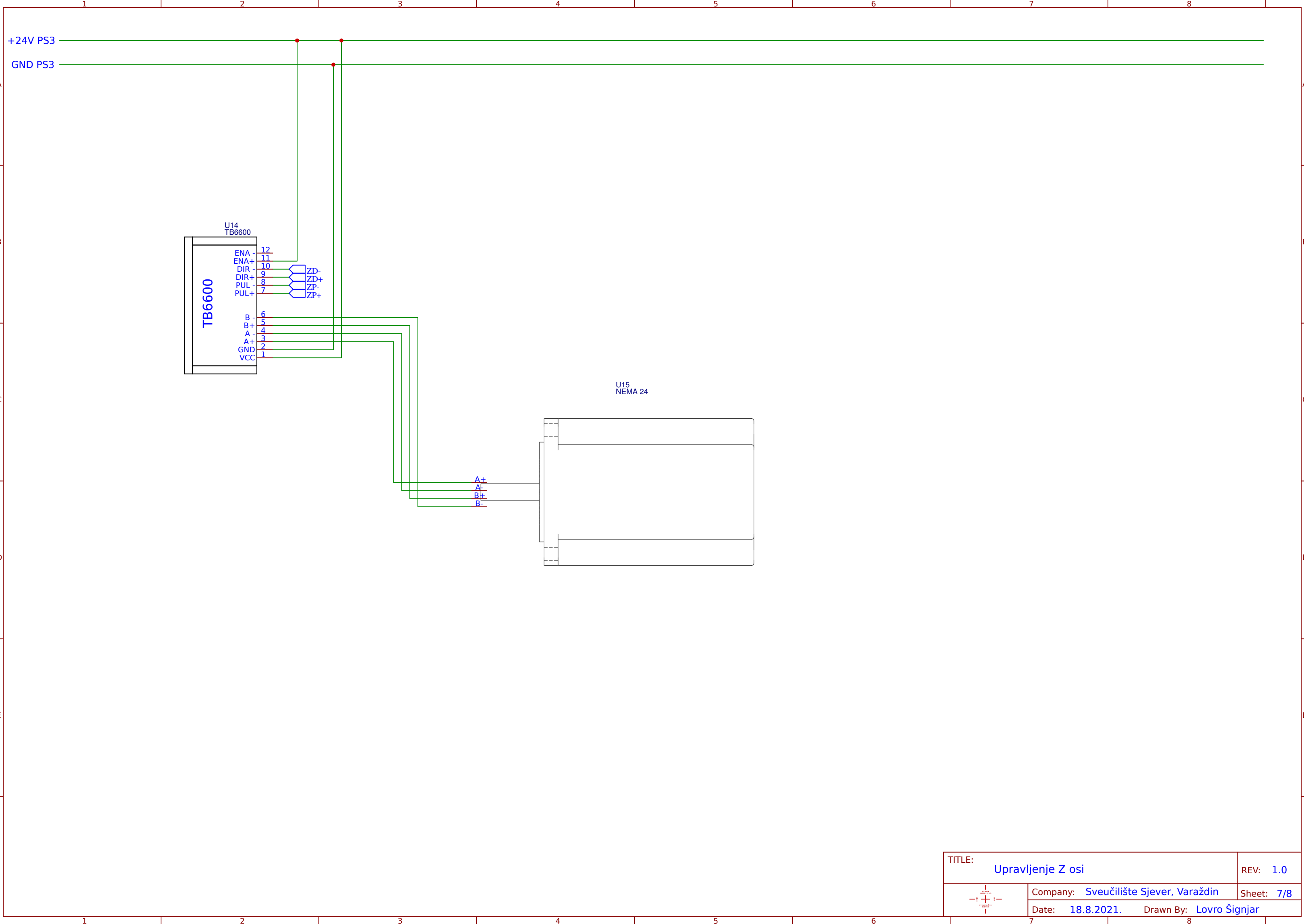

TITLE:	Upravljenje Z osi	REV:	1.0
	Company: Sveučilište Sjever, Varaždin	Sheet:	7/8
	Date: 18.8.2021.	Drawn By:	Lovro Šignjar

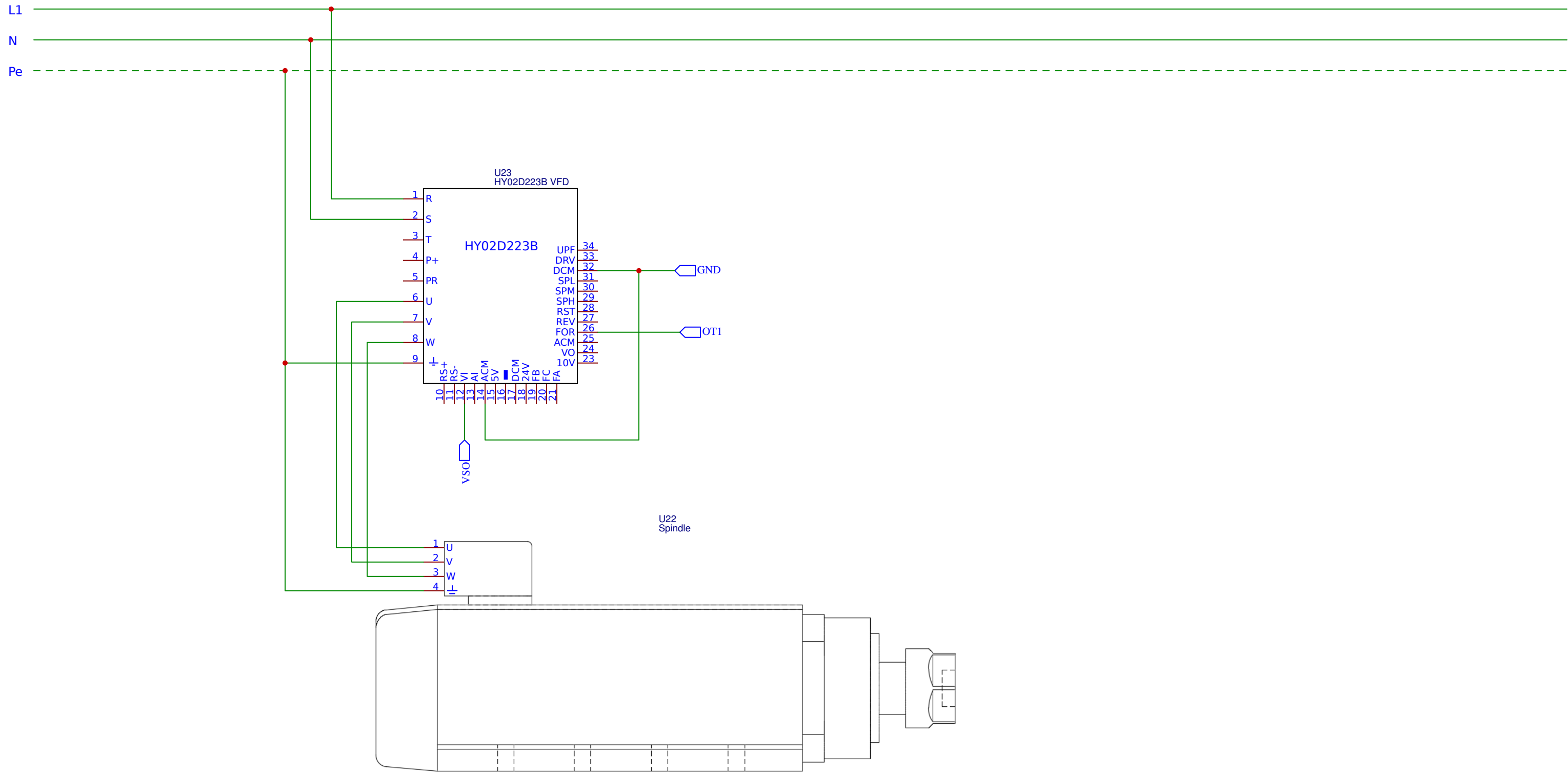

TITLE:	Upravljenje glodalicom	REV: 1.0
	Company: Sveučilište Sjever, Varaždin	Sheet: 8/8
	Date: 18.8.2021.	Drawn By: Lovro Šignjar