

# Slika

---

**Bogdan, David**

**Supplement / Prilog**

*Publication year / Godina izdavanja:* **2016**

*Permanent link / Trajna poveznica:* <https://urn.nsk.hr/urn:nbn:hr:122:951890>

*Rights / Prava:* [In copyright](#)/[Zaštićeno autorskim pravom.](#)

*Download date / Datum preuzimanja:* **2024-12-25**



*Repository / Repozitorij:*

[University North Digital Repository](#)

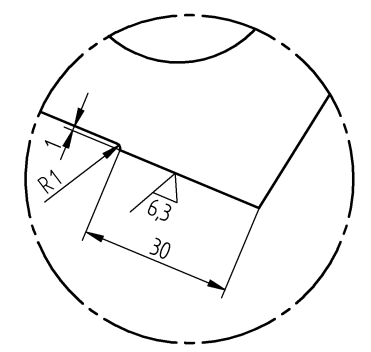
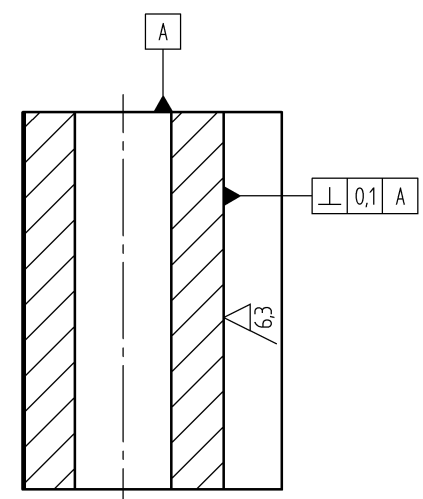
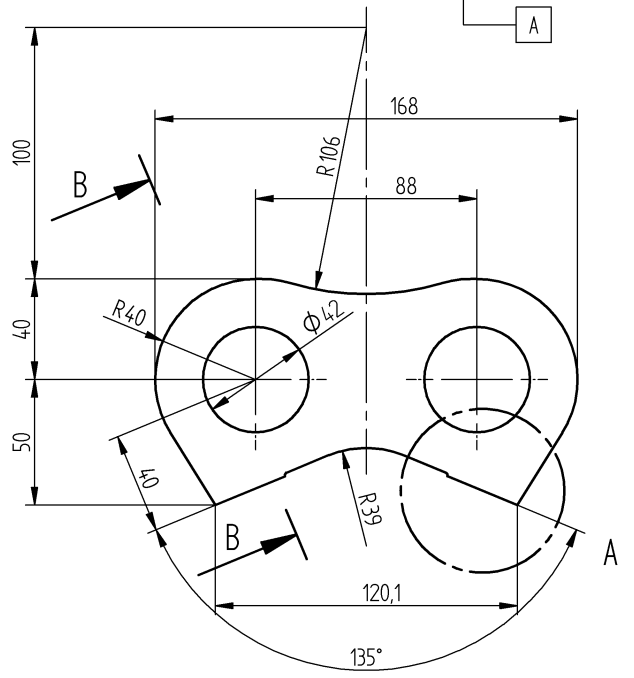
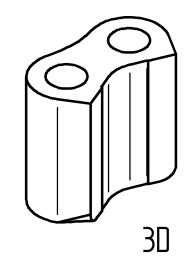
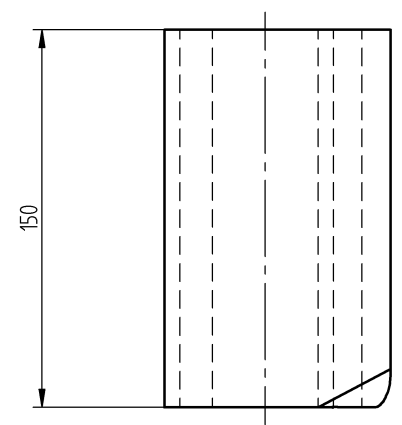
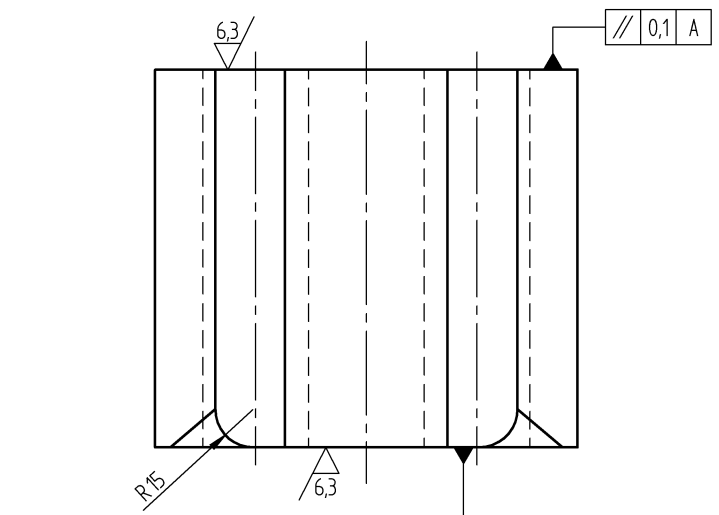

Schnitt / section B-B  
1:2

Ansicht / view A  
1:1

Alternativwerkstoff : 17CrNiMo6 (1.6587) / S690QL (1.8928)  
 alternative material : 17CrNiMo6 (1.6587) / S690QL (1.8928)

Toleranzen nach DIN 1683, GTB 17

Schutzvermerk DIN 34-1-D Copyright reserved Schwing GmbH	Format / SIZE: A 3	Datum / DATE: 25.01.05	Name / NAME: J.Richter	Sicherheitsteil / SAFETY PART: S1	Benennung / NAME: Halter Holder	Allgemeintoleranz siehe Werknorm 1.5 / General Tolerances WN-No.: 1.5		
	Ers. durch / REPL. BY:	Geprüft / CHECKED BY: 01.07.2010	LMEINKE	Gewicht / WEIGHT (kg): 10,840		Dokumenteninfotanz-Nr. / DIS NO: 1000035866	Material-Nr. / PART NO: 10213160	
	Ers. für / REPL. FOR:	Normgeprüft / APPROVED BY:		Maßstab / SCALE: 1:2		Rev. / REV: 07	Datum / DATE: 28.06.2010	Name / NAME: NJURIC
	Ung.-Datum / EXPIRY DATE:	Werkstoff / Werkstoff-Nr.: / MATERIAL / MATERIAL CODE: G18NiMoCr3-6 / 16759		Nicht abmessen / DO NOT SCALE		Blatt-Nr. / SHEET: 1 / 1		
						<b>SCHWING</b>		